

Aluminum Fluted and Smooth Round Poles

Fluted and Smooth Round Aluminum poles are built from extruded fluted or smooth aluminum tubing and are offered as direct burial or with a high-strength die cast aluminum base and are available side drilled for arm mounted area lighting luminaires or with tenon mounts for flood and post top luminaires. Typical area lighting applications include retail centers, industrial parks, schools and universities, parks and pedestrian pathways and gathering spaces. Mounting heights to 10-16 feet for fluted and 10-20 feet for smooth can be used based on selected luminaire application.

Specifications and Features:

Pole Specifications:

The Pole Shaft is of Uniform Wall Thickness and is One-Piece Extruded 6063 Aluminum Alloy With T6 Temper. Available in 4" Diameter. Anchor Base is Die Cast From 356 Alloy Aluminum and is Heat Treated to a T6 Temper After Welding. Wall Thickness: 5mm (.196").

Finish:

Textured Architectural Black Powdercoat Finish, Baked to Ensure Maximum Paint Adhesion, Hardness and Durability.

Anchor Bolts:

Anchor Bolts are Included, Sized Based on Pole Data Charts for the Selected Pole Size.

Hand Hole:

Die Cast Aluminum Reinforced Hand Hole and Cover with Ground Screw.

Base Cover:

Poles are Provided with a Two-Piece Formed Aluminum Base Cover that is Easily Assembled and Fitted Over Pole Base.

Pole Length:

Poles are Available in Standard Lengths as Shown in the Order Matrix. Poles can be Custom Cut to Order. Consult Factory.

Mounting Options:

Available Side Drilled for 1 side, 2@180 Degrees, 3@90 Degrees or 4@90 Degrees, Includes UV-Stabilized Polycarbonate Top Cover (4" Only).

Poles May Also Be Ordered With 2 $\frac{3}{8}$ " OD or 2 $\frac{1}{8}$ " OD Tenons for Use With Post Top Decorative Luminaires, Flood/Area Slip Fitter Fixtures, or Any of a Wide Variety of Pole Top Mounting Accessories. Stainless Steel Hardware.

Tenon Sizes:

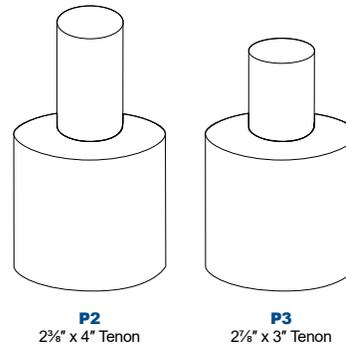

Drill Template:

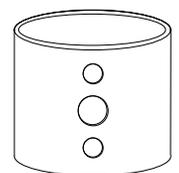

Side Drills:
1 Side, 2 at 180°,
3 at 90°, 4 at 90°

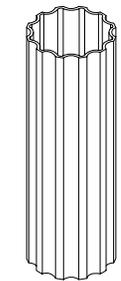

4" Round Fluted



4" Round Smooth



Project Information:

Project Name:	Fixture Type:
Complete Catalog #:	Date:
Comments:	

Notes:

- Side Drilled poles include UV-stabilized polycarbonate pole cap.
- All poles include anchor bolts standard, consult dimension table for size based on pole dimensions.
- All poles include square 2-piece black base cover.

Order Information Example:		VVDPARF420ABBP3	***Adder Applies		
VVDPARF			B		
Model	Shaft/Height/Style	Color	Pole Top Mounting	Options	
VVDPARF Fluted Aluminum Extruded Pole VVDPARS Smooth Aluminum Extruded Pole	416AB =16' Anchor Base Pole* 422DB =22' Direct Burial Pole* *Fluted PARF Only 420AB =20' Anchor Base Pole** **Smooth PARS Only CUT =Pole Cutting***	B =Black CS =Custom (Adder Applies)	D1 =Drilled 1 Side D2 =Drilled 2 Sides at 180 D3 =Drilled 3 Sides at 90 D4 =Drilled 4 Sides P2 =2 1/2" x 4"H Tenon*** P3 =2 1/2" x 3"H Tenon*** N =No Pole Top Mounting	(Leave Blank) =No Options LAB =Less Anchor Bolts (2) LBC =Less Base Cover (3)	

Wind Loading and Dimensional Data:

Pole Description		80 MPH	90 MPH	100 MPH	110 MPH	120 MPH	130 MPH	140 MPH	150 MPH	160 MPH	170 MPH	180 MPH	200 MPH
Shaft Size & Wall Thickness	Mounting Height	Max EPA (SQ FT)	Max EPA (SQ FT)	Max EPA (SQ FT)	Max EPA (SQ FT)	Max EPA (SQ FT)	Max EPA (SQ FT)	Max EPA (SQ FT)	Max EPA (SQ FT)	Max EPA (SQ FT)	Max EPA (SQ FT)	Max EPA (SQ FT)	Max EPA (SQ FT)
VVDPARF, VVDPARS	12'	24.20	19.20	14.80	11.80	10.95	9.06	7.58	6.37	5.38	4.57	3.88	0.65
	14'	19.40	15.40	11.60	9.20	8.61	7.02	5.78	4.76	3.93	3.25	2.67	-
	16'	15.00	12.00	8.90	6.93	6.64	5.31	4.27	3.41	2.70	2.14	1.64	-
VVDPARS	20'	8.00	6.00	4.50	3.45	3.31	2.71	2.12	1.70	1.20	0.55	-	-

NOTES:

1. Maximum EPA (Effective Projected Area) based on "C" Exposure.
2. EPAs are approximate, specific to location and local codes. Consult engineer for specific application.
3. Allowable EPA Weight Load (LBS): To determine maximum pole loading weight, multiply allowable EPA by 30 LBS.
Example: VVDPARF 16' pole in 120 mph zone = 199.2 LBS (6.64 x 30)
4. Variations from sizes above are available upon inquiry at the factory.
5. Satisfactory performance of poles is dependent upon the pole being properly attached to a supporting foundation of adequate design.

Pole Data:

Anchor Base Pole

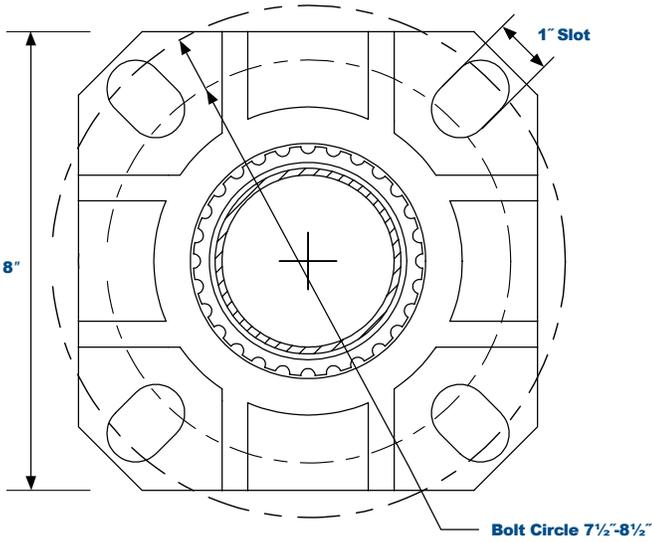

Shaft Base Size	Bolt Circle A	Base Size B	Base Thickness C	Anchor Bolt Size
VVDPARF4/VVDPARS4	7 1/2"-8 1/2" (191-215mm)	8" (203mm)	3/4" (19mm)	5/8" x 18"

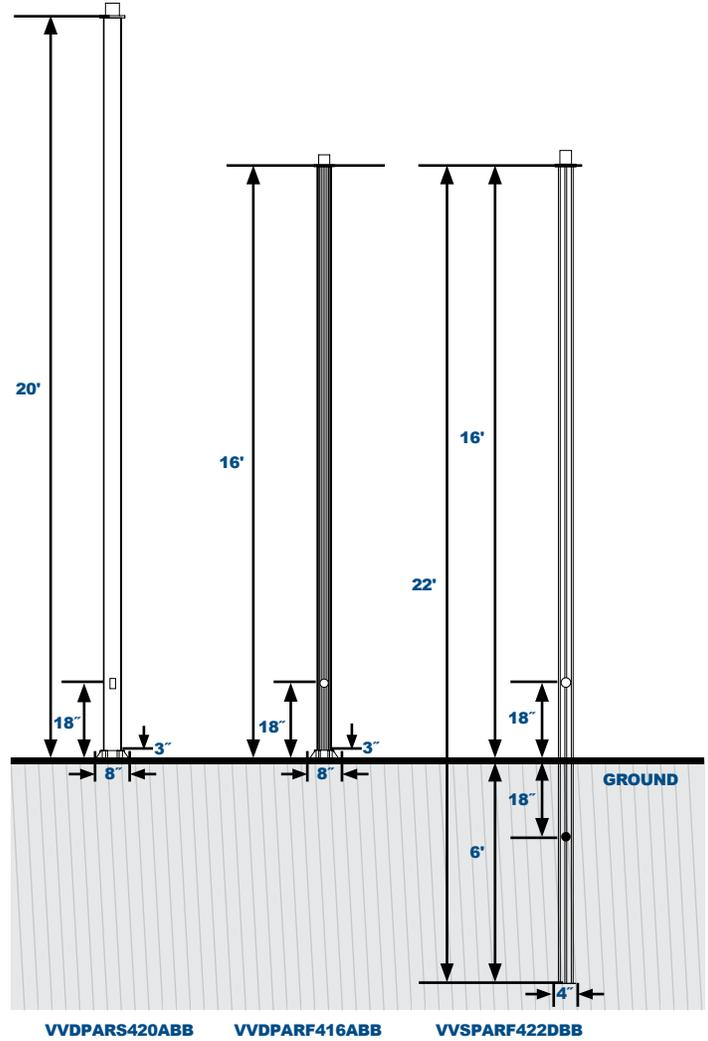

Pole Top Mounting:

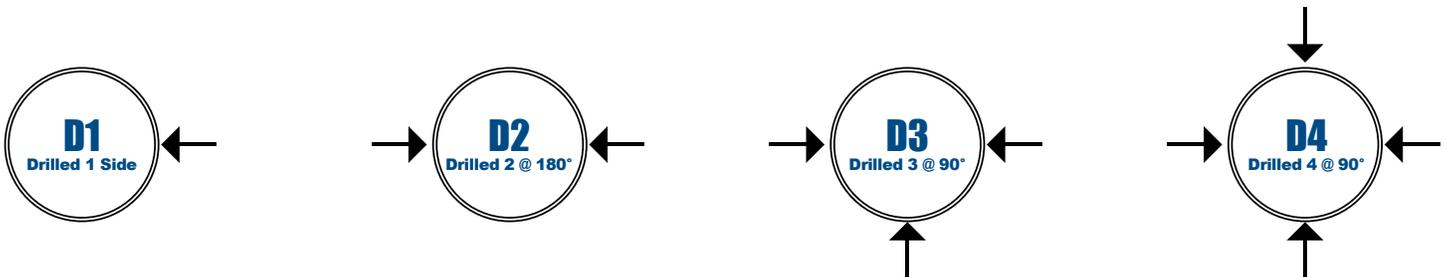

Round Aluminum Pole Mounting Options (Order separately, field installed.)

Spoke Brackets: Bronze Finish, Spoke Bracket have 7" Arms. Fit 2 1/2" (P2) Tenons.

All VVDPTSB Spoke Brackets are 9" high from the bottom edge to the top center of the cap



Single Spoke Bracket
VVDPTSB1SZ



Twin Spoke Bracket,
90° Arms
VVDPTSB290SZ



Twin Spoke Bracket,
180° Arms
VVDPTSB2180SZ

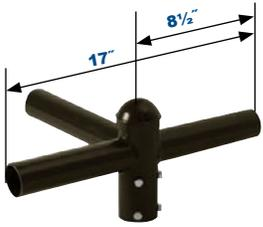

Triple Spoke Bracket, 90° Arm
VVDPTSB390SZ*



Triple Spoke Bracket, 120° Arms
VVDPTSB3120SZ*

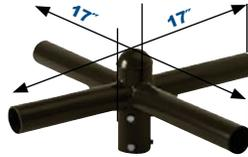

Quad Spoke Bracket, 90° Arms
VVDPTSB490SZ*

*Non-stock item. Consult factory for lead time.

Tenon Adaptors: Fit 2 1/2" (P2) Tenons.



Retrofit Tenon Adaptor for
2 1/2" Tenons
VVDPSRTNB

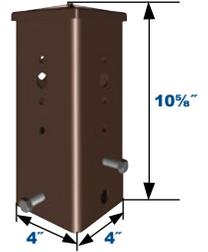

Pole Tenon Adaptor
VVDPTASUNVZ

4" Vertical Tenon Pole Top Fitters: Black Finish

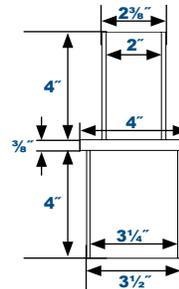

2 1/2" Single Round
Vertical Tenon (P2)
VVDPSRA42B

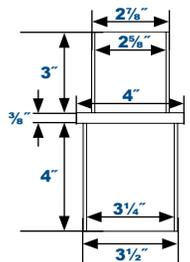

2 1/2" Single Round
Vertical Tenon (P3)
VVDPSRA43B

Decorative Aluminum Pole Mounting Options (Order separately, field installed.)

Dual Mounting Arm: Black Finish, Accepts 3" Diameter Fitters, Fits 3" Tenon



Dual Head Decorative Pole Arm
VVDPADAB

Wall Mounting Bracket: Black Finish, Accepts 3" Diameter Fitters

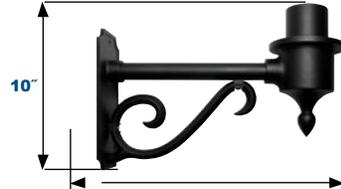

Single Decorative Wall Mount Bracket
VVDPWASAB

Wall Mounting Bracket:



WallMount Bracket
VVDPRSWMBZ

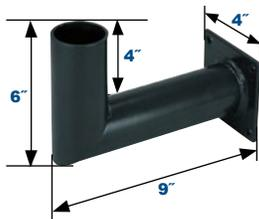

Wall Mount 90° Bracket
VVDPRSWMB90Z
Wt lbs 4.5, EPA 0.3

Bases:

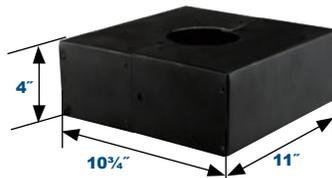

VVDPRA4CVB



VVDPB24A4B

Replacement Parts
(Order Separately, Field Installed)

VVDPRA4CVB Square Cover for 4" Pole, Black Finish

VVDPB24A4B Two-Piece Base for 4" Pole, Black Finish

VVDPARF/VVDPARS

Aluminum Fluted and Smooth Round Poles

VVDPB Series

Cast Aluminum Decorative Clamshell Bases

Decorative Clamshell Bases are designed to create a clean decorative look and cover pole base anchoring hardware. Two styles are available in matching finish to coordinate with pole selection.

Specifications and Features:

Clamshell Bases:

Die cast aluminum, Stainless Steel Hardware. VVDPBR1 and VVDPBS1 include sets of inserts that allow use on 4" round poles.

Finish:

Textured architectural powdercoat finish, baked to ensure maximum paint adhesion, hardness and durability.

Pole Fit:

Bases are designed to fit poles based on dimensions shown.



VVDPBR1

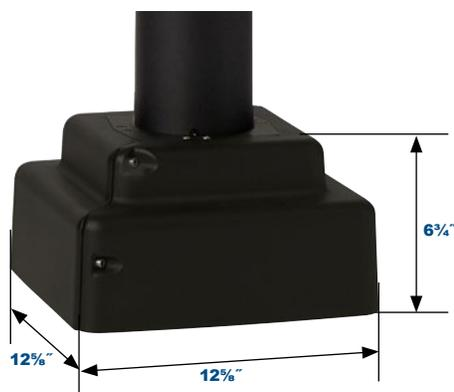

VVDPBS1

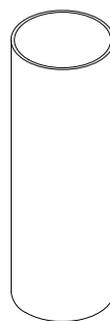

**Smooth Pole
4" Dia
VVDPARS**

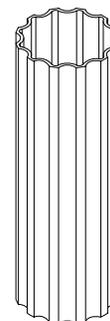

**Fluted Pole
4" Dia
VVDPARF**

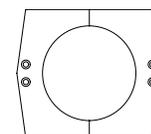

4" Round Inserts.

Can be used with VVDPBSRA, VVDPARS, VVDPARF, VVDPRTS, and VVDPSSS Poles.

Order Information Example:	
	VVDPBR1B
Model	Color
VVDPBR1=Round Base VVDPBS1=Square Base	B=Black P=Platinum (PBR1 Only) Z=Bronze C=Custom (Consult Factory)

Project Information:	
Project Name:	Fixture Type:
Complete Catalog #:	Date:
Comments:	

Notes: