

Direct Burial Straight Round Steel Poles

Size: 4", 5"

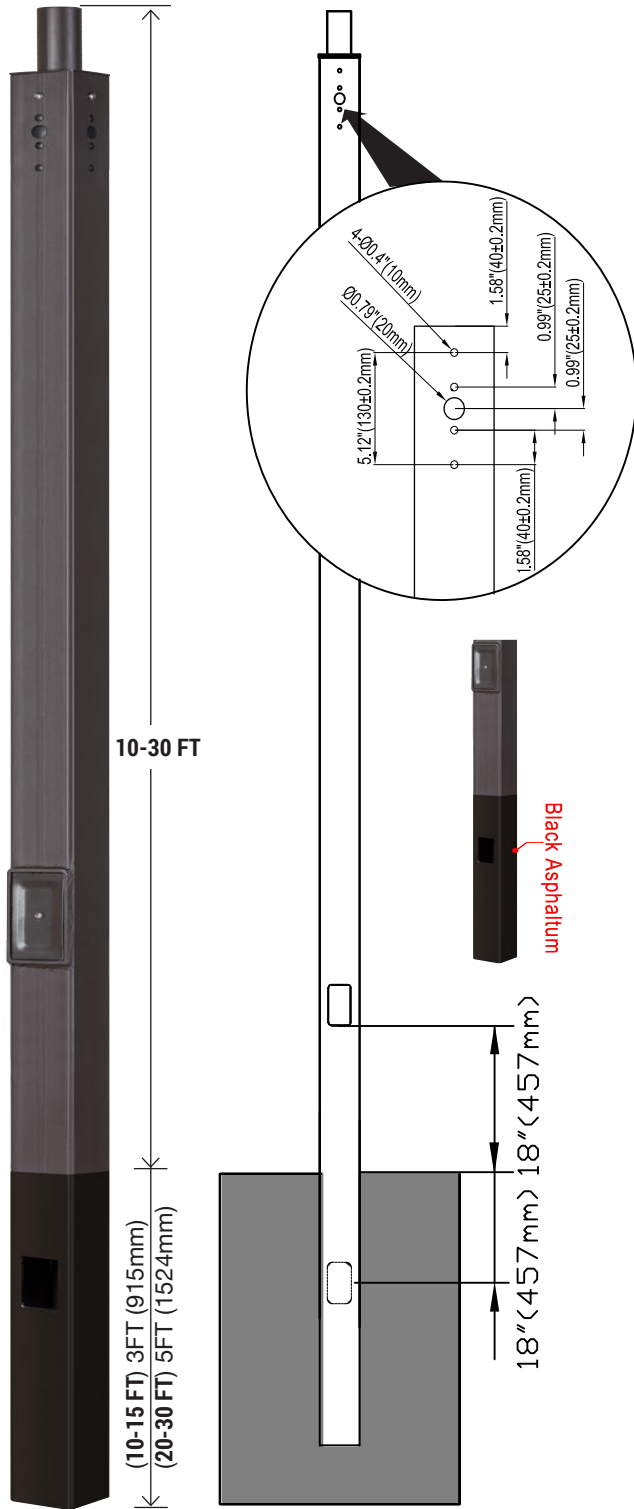

Direct Burial Straight Round poles are built from high strength steel tube and are available side drilled for arm mounted area lighting luminaires or with tenon mounts for flood and post top luminaires. Typical area lighting applications include retail centers, industrial parks, schools and universities, public transit and airports, office buildings and medical facilities. Mounting heights of 10 to 30 feet can be used based on selected luminaire application.

5J 5-@56-@HM

5J 5-@56-@HM
 5J 5-@56-@HM
 5J 5-@56-@HM

FINISH:

Textured architectural powder-coat finish, baked to ensure maximum paint adhesion, hardness and durability.

ANCHOR BOLTS:

Anchor bolts are sized based on pole data charts for the selected pole size.

HAND HOLE:

Cast iron reinforced hand hole and cover with ground screw.

BASE COVER:

Base cover is a two-piece formed steel cover that is easily assembled and fitted over the pole base.

POLE LENGTH:

Poles are available in standard lengths as shown in the order matrix. Poles can be custom cut to order. Consult factory.

ACI BH-B :

ACI BH-B :
 ACI BH-B :
 ACI BH-B :

SPECIFICATIONS: Conforms to ASTM-A 500 Grade B: Minimum Yield Strength of 46,000 PSI.

6@57? 5GD<5@H A.

6@57? 5GD<5@H A.
 6@57? 5GD<5@H A.
 6@57? 5GD<5@H A.

K 5F F 5BHM

K 5F F 5BHM
 K 5F F 5BHM
 K 5F F 5BHM

SPECIFICATION	10FT	15FT	20FT	25FT	30FT
⌘ : cch					
⌘ : cch					
&⌘ : cch	L = 3.0 (m)	L = 4.6 (m)	L = 6.1 (m)	L = 7.6 (m)	L = 9.1 (m)
&⌘ : cch					
' ⌘ : cch					

Direct Burial Straight Round Steel Poles

Size: 4", 5"

Fixture Mounting:

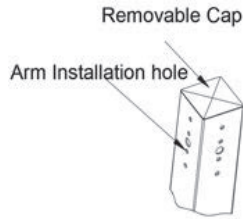

SIDE MOUNT

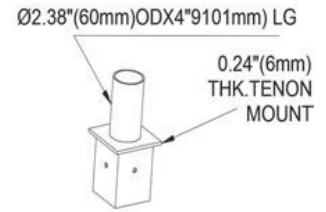

POST TOP

DIMENSION DATA

HEIGHT	GAUGE	SIZE	SUBSURFACE DEPTH	(LBS)	EPA 70	EPA 80	EPA 90	EPA 100	EPA 110	EPA 120	EPA 130	EPA 140
10ft	11	4"	3 ft	75	28.2	23.5	20.3	19.4	17.3	15.6	12.3	9.8
15ft				99	18.2	15.5	13.1	11.5	9.9	7.4	5.2	3.8
20ft			132	12.2	10.3	8.8	7.2	6.1	4.6	2.2	1.0	
25ft			154	11.9	8.9	7.7	6.1	5.6	4.2	1.1	0.5	
30ft		5"	231	9.6	7.6	6.1	5.8	4.8	3.3	2.5	1.5	

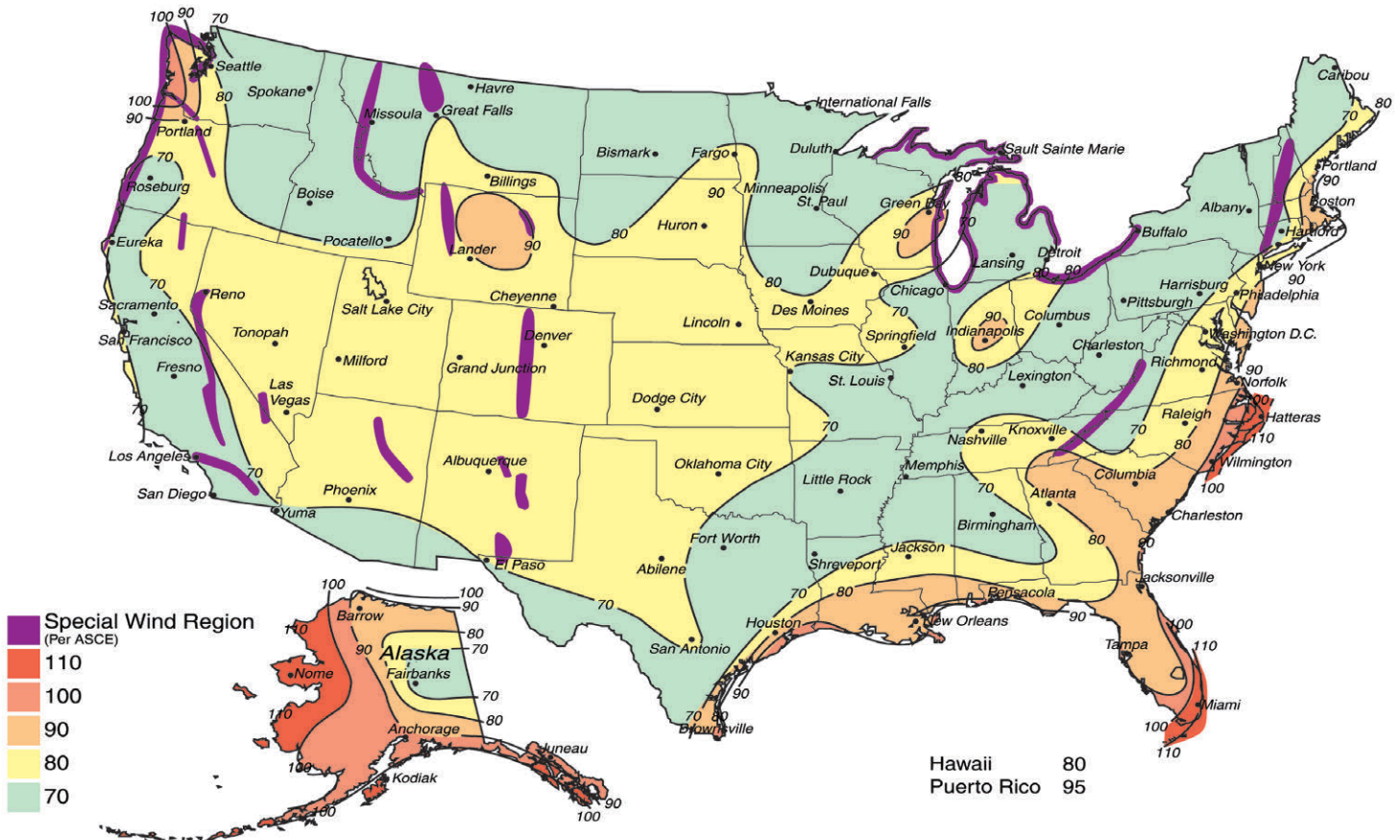

Direct Burial Straight Round Steel Poles

Size: 4", 5"

ORDERING INFORMATION EXAMPLE: **VDDBR-10FT-BZ-DH**

† 5XXYf 5dd JYg

VVDSSP	10FT	BZ	DH	
FAMILY	HEIGHT	FINISH	POST TOP MOUNTING	
VDDBR	10FT - (3.0 M) 15FT - (4.6 M) 20FT - (6.1 M) 25FT - (7.6 M) 30FT - (9.1 M)	BZ - Bronze BK - Black* WT - White* CS - Custom*	PT - Post Top - Includes 1" #10 C8 Tenon Mount SM - Side Mount*	

FIXTURE CONFIGURATIONS

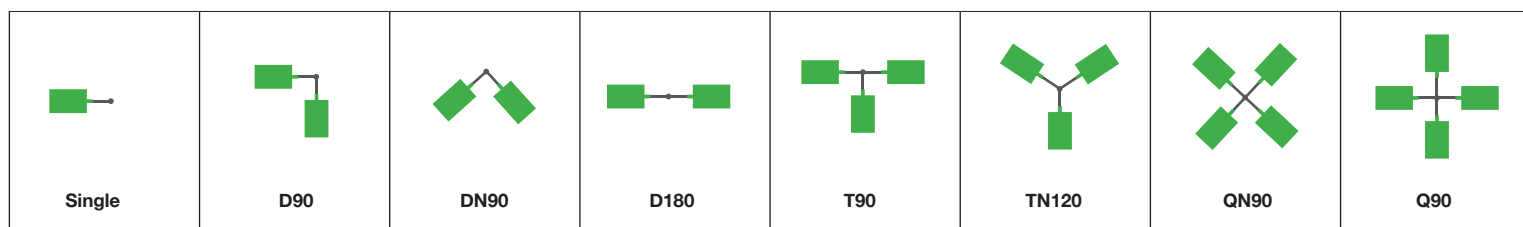

INSTALLATION

Installation Guide

Step 1. After digging the corresponding size foundation hole by pressing the table at the location of the light pole installation, put the embedded end of the light pole into the hole, and keep it perpendicular to the ground, and fix it with concrete casting.

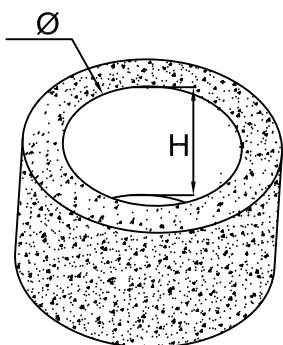
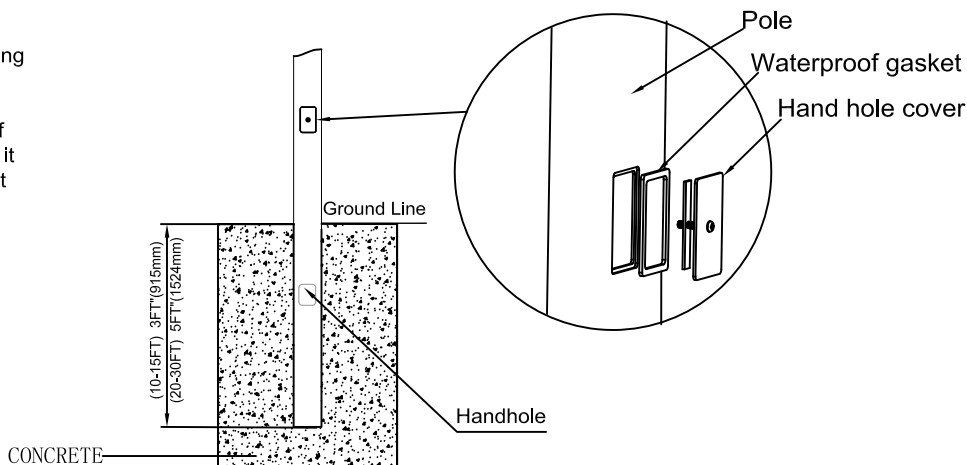

Reference design of Concrete size		
Specifications	Ø	H
10-15FT	31.5"(800mm)	59.1"(1500mm)
20-30FT	35.4"(900mm)	82.7"(2100mm)

Foundation Design: We offer Foundation design references due to variations in soil structure across different areas, and we do not assume any responsibility for this variability.

Direct Burial Straight Round Steel Poles

Size: 4", 5"

SQUARE EXTERNAL MOUNT HORIZONTAL TENON		• To mount 2/3/4 fixtures on an existing pole	
	<p>Low Profile Bullhorn with 3 Tenons WSDVTS4R3TD MAX EPA: 1.6 Finish: Dark Bronze The Bracket is designed to mount over 2-3/8" O.D. vertical tenon.</p>		<p>Low Profile Bullhorn with 2 Tenons WSDVTS4R2TD MAX EPA: 1.0 Finish: Dark Bronze The Bracket is designed to mount over 2-3/8" O.D. vertical tenon.</p>
	<p>Triple 120° Horizontal Tenon Adapter WSDQT1203TD MAX EPA: 1.4 Finish: Dark Bronze The Bracket is designed to mount over 2-3/8" O.D. vertical tenon.</p>		<p>Quad 90° Horizontal Tenon Adapter WSDQT904TD MAX EPA: 1.6 Finish: Dark Bronze The Bracket is designed to mount over 2-3/8" O.D. vertical tenon.</p>
WALL BRACKET • Attaches to any flat surface • Provides wiring access		MID-POLE TENON BRACKET	
	<p>90° Wall Mount Bracket with 2-3/8" O.D. Tenon WSDADP2590D MAX EPA: 0.6 Finish: Dark Bronze The 90° wall mount bracket with 2-3/8" tenon attaches flood and area fixtures to almost any surface: wall, roof, or wood pole. Provides wiring access and a built-in 2-3/8" O.D. tenon to mount a fixture with our adjustable slip-fitter. Suggested 3/8" diameter bolts for mounting.</p>		<p>2-3/8" OD Horizontal Tenon Mid-Pole Bracket WSDADP25D MAX EPA: 0.3 Finish: Dark Bronze 2-3/8" OD Horizontal Tenon Mid-Pole Bracket is designed to mount light fixture that is equipped with a adjustable slip-fitter onto a 2-3/8" OD horizontal tenon.</p>
	<p>180° Wall Mount Bracket with 2-3/8" O.D. Tenon WSDADP2518039 MAX EPA: 0.5 Finish: Dark Bronze The 180° wall mount bracket with 2-3/8" tenon attaches flood and area fixtures to almost any surface: wall, roof, or wood pole. Provides wiring access and a built-in 2-3/8" O.D. tenon to mount a fixture with our adjustable slip-fitter. Suggested 3/8" diameter bolts for mounting.</p>		<p>2-3/8" OD Horizontal Tenon Arc Adapter WSDADPBAR5D MAX EPA: 0.3 Finish: Dark Bronze For use with Round, non-tapered steel and aluminum poles. 2-3/8" OD Horizontal Tenon Mid-Pole Bracket is designed to mount light fixture that is equipped with a adjustable slip-fitter onto a 2-3/8" OD horizontal tenon.</p>
	<p>Square Triple 90° Horizontal Tenon Adapter WSDQT903TD MAX EPA: 1.5 Finish: Dark Bronze The Bracket is designed to mount over 2-3/8" O.D. vertical tenon.</p>		<p>Round Triple 90° Horizontal Tenon Adapter WSDSB25QD903 MAX EPA: 0.3 Finish: Dark Bronze The Bracket is designed to mount over 2-3/8" (60mm) O.D. vertical tenon. Triple" fixtures can be mounted to the Round External Mount Horizontal Tenon and adjusted horizontally.</p>
	<p>Low Profile Bullhorn with 4 Tenons WSDVTS4R4TD MAX EPA: 1.7 Finish: Dark Bronze The Bracket is designed to mount over 2-3/8" O.D. vertical tenon.</p>		<p>Four 180° Horizontal Tenon Adapter WSDRB25TR180 MAX EPA: 1.4 Finish: Dark Bronze The Bracket is designed to mount over 2-3/8" (60mm) O.D. vertical tenon. Four" fixtures can be mounted to the Round External Mount Horizontal Tenon and adjusted horizontally.</p>

Direct Burial Straight Round Steel Poles

Size: 4", 5"

ROUND EXTERNAL MOUNT HORIZONTAL TENON - To mount 2/3/4 fixtures on an existing pole			
	<p>Double 90° Horizontal Tenon Adapter WDSB25TW90 MAX EPA: 0.6 Finish: Dark Bronze The Bracket is designed to mount over 2-3/8" (60mm) O.D. vertical tenon. Two fixtures can be mounted to the Round External Mount Horizontal Tenon and adjusted horizontally.</p>		<p>Triple 120° Horizontal Tenon Adapter WDSB5TR120 MAX EPA: 0.7 Finish: Dark Bronze The Bracket is designed to mount over 2-3/8" (60mm) O.D. vertical tenon. Three fixtures can be mounted to the Round External Mount Horizontal Tenon and adjusted horizontally.</p>
	<p>Double 180° Horizontal Tenon Adapter WDSB5TW180 MAX EPA: 0.4 Finish: Dark Bronze The Bracket is designed to mount over 2-3/8" (60mm) O.D. vertical tenon. Two fixtures can be mounted to the Round External Mount Horizontal Tenon and adjusted horizontally.</p>		<p>Quad 90° Horizontal Tenon Adapter WDSB25QD90D MAX EPA: 0.3 Finish: Dark Bronze The Bracket is designed to mount over 2-3/8" (60mm) O.D. vertical tenon. Four fixtures can be mounted to the Round External Mount Horizontal Tenon and adjusted horizontally.</p>
	<p>Single Spoke Bracket Tenon Adapter WDSB25S90D MAX EPA: 0.4 Finish: Dark Bronze The Bracket is designed to mount over 2-3/8" (60mm) O.D. vertical tenon. One fixture can be mounted to the Round External Mount Horizontal Tenon and adjusted horizontally.</p>		<p>180° Double Bullhorn WDRB25D180 MAX EPA: 0.9 Finish: Dark Bronze The Bracket is designed to mount over 2-3/8" (60mm) O.D. vertical tenon. Two fixtures can be mounted to the Round External Mount Horizontal Tenon and adjusted horizontally.</p>
	<p>180° Triple Bullhorn WDRB25TR180D MAX EPA: 1.4 Finish: Dark Bronze The Bracket is designed to mount over 2-3/8" (60mm) O.D. vertical tenon. Three fixtures can be mounted to the Round External Mount Horizontal Tenon and adjusted horizontally.</p>		<p>90° Quad Bullhorn WDRB25QD90 MAX EPA: 1.5 Finish: Dark Bronze The Bracket is designed to mount over 2-3/8" (60mm) O.D. vertical tenon. Four fixtures can be mounted to the Round External Mount Horizontal Tenon and adjusted horizontally.</p>
	<p>90° Wall Mount Bracket with 2-3/8" O.D. Tenon WSDADP2590HD MAX EPA: 0.7 Finish: Dark Bronze The 90° wall mount bracket with 2-3/8" tenon attaches flood and area fixtures to almost any surface: wall, roof, or wood pole. Provides wiring access and abuilt-in 2-3/8" O.D. tenon to mount a fixture with our adjustable slip-fitter. Suggested 3/8" diameter bolts for mounting. Mounting h</p>		<p>Double 180° Horizontal Tenon Adapter WDRB5TR180D MAX EPA: 1.0 Finish: Dark Bronze The Bracket is designed to mount over 2</p>
	<p>Triple 120° Horizontal Tenon Adapter WDSB25TR120V MAX EPA: 1.5 Finish: Dark Bronze The Bracket is designed to mount over 2-3/8" (60mm) O.D. vertical tenon. Three fixtures can be mounted to the Round External Mount Horizontal Tenon and adjusted horizontally.</p>		<p>Double 180° Wall Mount Bracket with 2-3/8" O.D. Tenon WSDADP25180H MAX EPA: 1.4 Finish: Dark Bronze The 180° wall mount bracket with 2-3/8" tenon attaches flood and area fixtures to almost any surface: wall, roof, or wood pole. Provides wiring access and abuilt-in 2-3/8" O.D. tenon to mount a fixture with our adjustable slip-fitter. Suggested 3/8" diameter bolts for mounting. Mounting holes are spaced 3-1/4" apart.</p>