

## Product Description

The Iris EX Class 1, Division 1 Hazardous Location flood light luminaire is designed to replace HID lighting systems from 100w to 400w HPS. Typical lighting applications include oil and gas, chemical, ocean, marine, aerospace, metal treatment, food, and alcohol industries. The fixture is designed for high humidity, high dust, high temperature, and vapor locations.

> Quick Ship - In Stock, Ready to Ship

Project:		Type:
Location:		
Prepared By:		Date:
Comments:		

## Performance Summary

- Energy-efficient Philips Lumileds SMD LEDs with high efficacy >130 Lm/W
- USA assembled product with quick warranty support
- In stock and ships from several U.S. locations for quick delivery
- Better visibility than HID or fluorescent with crisp, white light
- Patented design with high quality components, excellent choice for retrofitting
- Listed for hazardous locations per UL844 for Class 1, Div 1, Groups C, D
- Heavy duty and high impact resistance
- Solid State with high-shock and vibration resistance - 3G vibration tested
- Patented heat dissipation design for optimum efficiency - T4 temperature rating
- National listing lab tested to IES standards with Type V wide 120 degree optic
- High lumen maintenance exceeds DOE requirements
- 1/9th LED micro color binning enables tight color control
- Adjustable stainless steel yoke bracket included
- Copper-free aluminum housing with marine grade powdercoat finish
- Housing is sandblasted and polished for corrosion resistance, rust free and fadeless
- Streamlined housing, no rough edges or scraping, with SUS316 stainless steel hardware
- CNC machined LED boards are flatness controlled to 0.1mm to speed up heat dissipation
- Replaceable aluminum LED boards with copper tracings for best thermal management
- LED array manufactured using a state-of-the-art SMT machine
- Copper condensation valve balances the air pressure and prevents water vapor accumulation
- Cooling fins are added to the heatsink for low temperature and higher efficiency
- Polycarbonate lens over the LEDs
- Patented double waterproofing design on the radiator and module to prevent condensation
- Advanced constant current Meanwell power supply in integrated junction box
- Fast turn on with no warm up or cold start issues
- High power factor with IC controlled LED circuits and low THD driver
- Low junction temperature for long life and low lumen depreciation
- Instant illumination and restrike with no warm up or cold start issues
- Contains no mercury, lead, infrared or UV radiation and cool to the touch
- Commercial CRI: RA>80, enhances original colors
- Operating temperature: -40 to 60 degrees celsius
- 100,000 hour LED life - IP66 rated for outdoor locations
- Certifications: CE, RoHS, TUV, IECEx, IEC, ABS, energyAPI, ETL, cETL
- 10 year limited warranty

## Iris LX C1D1 Linear

Class 1, Division 1 Hazardous Linear  
LED Luminaire



Vivid Leds, Inc.  
PO BOX 9  
Sellersburg, IN 47172  
330-809-0431  
www.vividleds.us

Dimensions, specifications, and product pictures are subject to change without notice.

---

## Applications:

### Oil and Gas industry

- All petroleum production and refining
- Petroleum loading and transportation
- Petroleum storage and retail
- LNG industry
- All mining operations and service

### Chemical industry

- All types of paint facilities
- Chemical production and storage

### Ocean, marine and aerospace field

- Ocean platform operation facilities and structure
- Aerospace clean room and production
- Ocean vessel operations

### Metal treatment

- Steel and aluminum factories
- Pumping stations in any environment
- Metal smelting, foundry and fabrication

### Food and alcohol industry

- Flour and fine particle production and storage
- Food and distilling production
- Alcohol industry



---

## Explosion Protection:

### UL844

- Class I, Division 1, Groups C, D
- Class I, Division 2, Groups A, B, C, D
- Class II, Division 1, Groups E, F, G
- Class II, Division 2, Groups F, G
- Class III

### Marine

- UL 1598, UL1598A
- ABS



Vivid Leds, Inc.  
PO BOX 9  
Sellersburg, IN 47172  
330-809-0431  
www.vividleds.us

Dimensions, specifications, and product pictures are subject to change without notice.

## Mounting Methods:

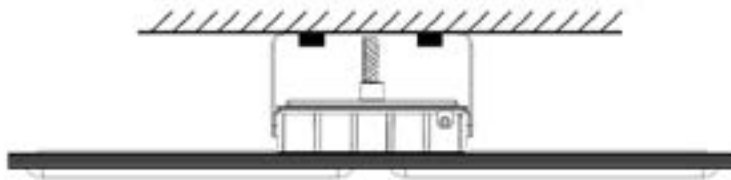

Ceiling Mount

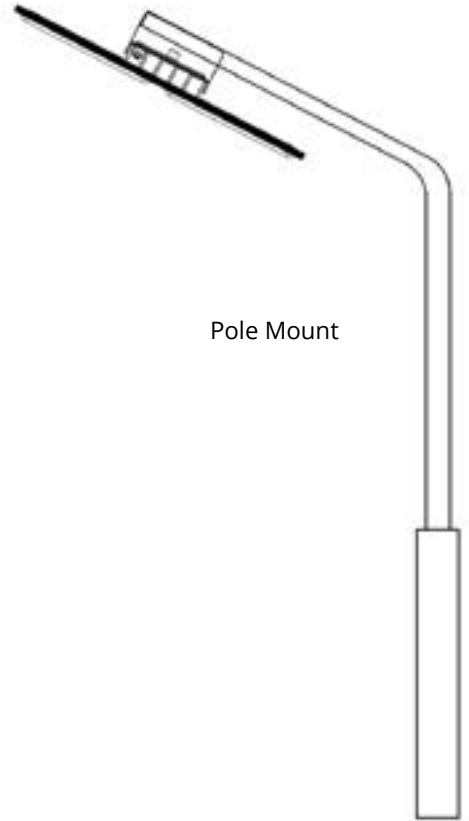

Pole Mount

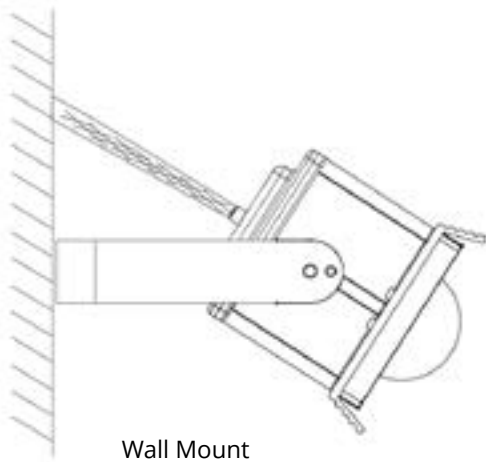

Wall Mount

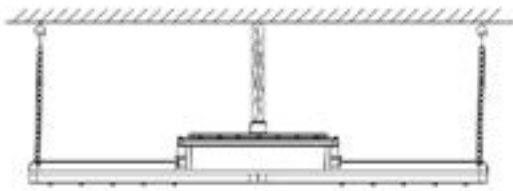

Chain Mount

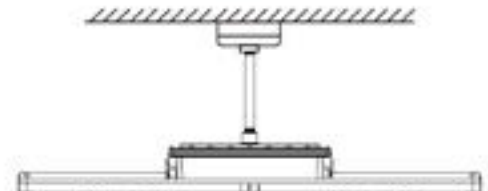

Conduit Pendant



Vivid Leds, Inc.  
PO BOX 9  
Sellersburg, IN 47172  
330-809-0431  
www.vividleds.us

Dimensions, specifications, and  
product pictures are subject to  
change without notice.

The product on this page is a manufactured to order, non-stocking item. This product cannot be returned for refund or credit.

## Light Distribution:

	Center Beam fc	Beam Width	
4ft	683fc	11ft	11ft
8ft	170fc	21ft	22ft
12ft	73fc	32ft	33ft
16ft	39fc	43ft	45ft
20ft	26fc	53ft	56ft

■ Vert, Spread; 120°  
■ Horiz, Spread; 120°

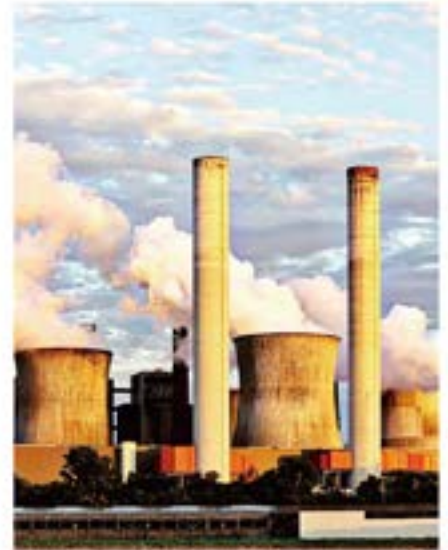

## Dimensions:

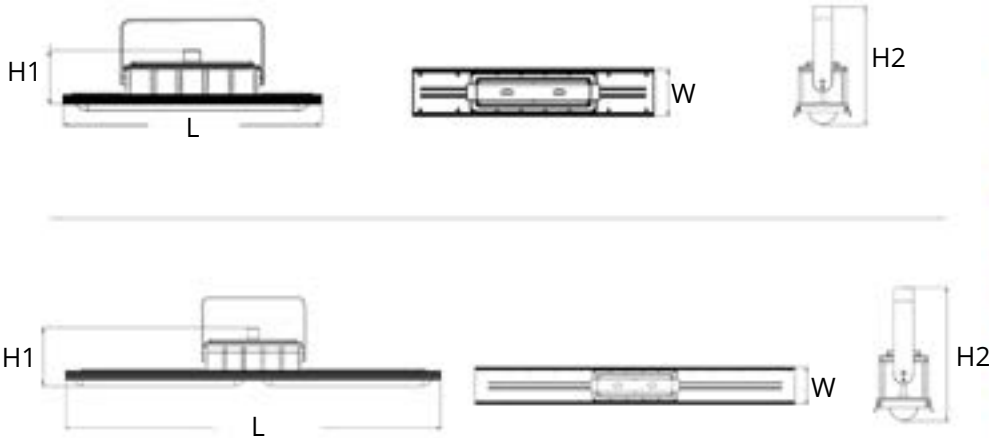

## Models:

- WDEX040I4N - 4' - 40W - 5600 Lm - 46.1" (L) x 5.5" (W) x 5.2" (H1) x 9.5" (H2) - 41 Lbs
- WDEX050I2N - 2' - 50W - 7000 Lm - 23.3" (L) x 5.5" (W) x 5.2" (H1) x 9.5" (H2) - 27 Lbs
- WDEX060I4N - 4" - 60W - 8400 Lm - 46.1" (L) x 5.5" (W) x 5.2" (H1) x 9.5" (H2) - 41 Lbs
- WDEX080I4N - 4' - 80W - 12000 LM - 46.1" (L) x 5.5" (W) x 5.2" (H1) x 9.5" (H2) - 41 Lbs
- WDEX100I4N - 4" - 100W - 14000 Lm - 46.1" (L) x 5.5" (W) x 5.2" (H1) x 9.5" (H2) - 41 Lb

## Ordering Information:

Part Number:

\*Adder Applies

Ordering Example: WDEX040I4N-50-T5-V27-PT

Family	CCT	Optic	Voltage	Finish	Accessories*
WDEX040I4N WDEX050I2N WDEX060I4N WDEX080I4N WDEX0100I4N	50 - 5000K	T5 - 120 Degrees	V27 - 100-277V V48 - 200-480V*	PT - Platinum	CBJ - Cable Junction Box SSP - Straight Swing Pipe 90JB - 90 Degree Wall Mount Junction Box 25JB - 25 Degree Wall Mount Junction Box



Vivid Leds, Inc.  
PO BOX 9  
Sellersburg, IN 47172  
330-809-0431  
www.vividleds.us

Dimensions, specifications, and product pictures are subject to change without notice.

The product on this page is a manufactured to order, non-stocking item. This product cannot be returned for refund or credit.

F2

Revised 4.12.22

---

## Accessories:



**CBJ - Junction Box** - Aircraft Aluminum A383 - Class 1 Division 1, Groups C,D; Class 1 Division 2, Groups A,B,C,D



**SSP - Straight Swing Pipe** - Iron with Powdercoat - Class 1 Division 1, Groups C,D; Class 1 Division 2, Groups A,B,C,D



**90JB - 90 Degree Wall Mount and Junction Box** - Aircraft Aluminum A383 - Class 1 Division 1, Groups C,D; Class 1 Division 2, Groups A,B,C,D



**25JB - 25 Degree Wall Mount Junction Box** - Aircraft Aluminum A383 - Class 1 Division 1, Groups C,D; Class 1 Division 2, Groups A,B,C,D



Vivid Leds, Inc.  
PO BOX 9  
Sellersburg, IN 47172  
330-809-0431  
[www.vividleds.us](http://www.vividleds.us)

Dimensions, specifications, and product pictures are subject to change without notice.

The product on this page is a manufactured to order, non-stocking item. This product cannot be returned for refund or credit.