

# Installation Instruction

1. Unscrew the larger tooth plug on the side of the lamp, use a Phillips screwdriver.

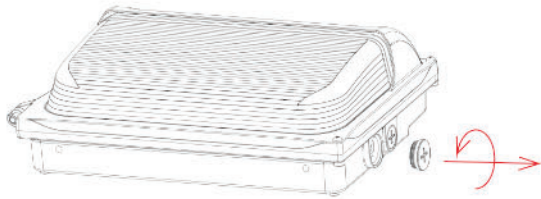

2. Adjust the power, color temperature, and light-sensing switches to the appropriate gear as needed. If the purchased lamps do not have color temperature optional or photocell sensor function, the color temperature optional or photocell sensor gear is empty.

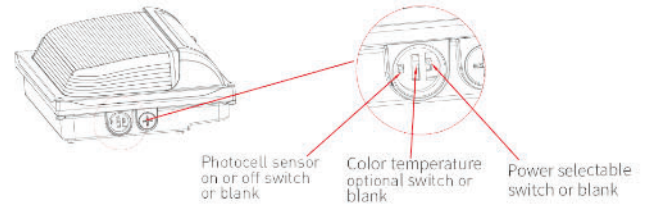

3. Attach the larger tooth plug to the light fixture, use a Phillips screwdriver.

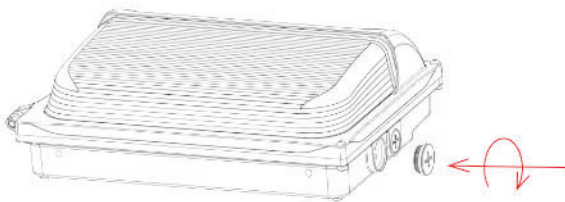

4. Use a screw driver to unscrew the lamp screws and remove the upper half of the fixture.

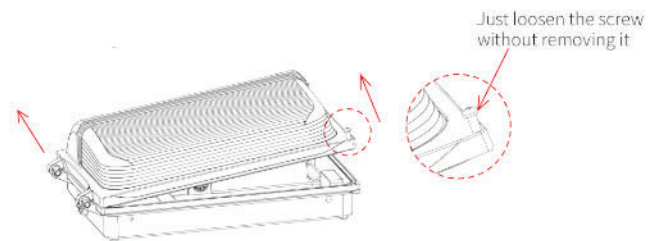

5. Unscrew the cover of the entry hole on the lamp base and remove the cover.

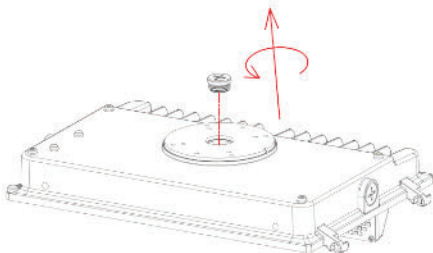

6. According to the embedded terminal box, punch the corresponding mounting hole on the light's mount.

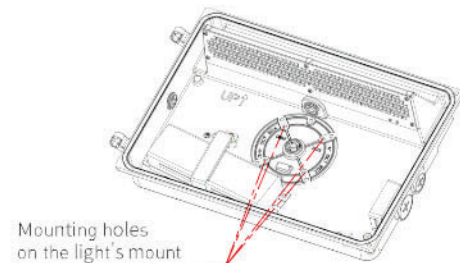

7. Put the input line in the embedded box passes through the waterproof pad and then passed through the lamp base.

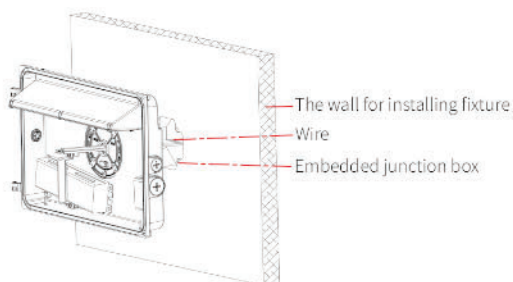

8. Use screw to lock the lamp base on the embedded junction box, And ensure the balance of the horizontal column.

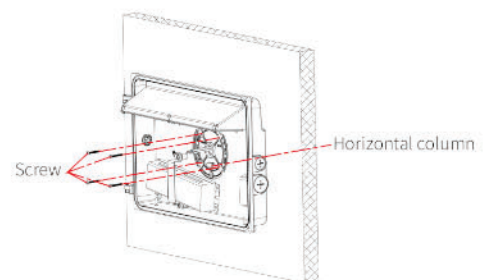

9. Connect the input wire and the dimming wire of the light , then put the connected wires into the embedded terminal box.

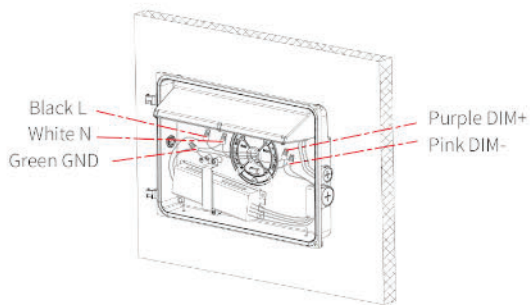

10. Turn the power or color temperature switch to the required position, and pull out the rubber plug at the water leakage hole.

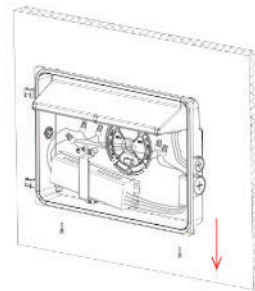

11. Insert the rotating shaft of the upper cover into the rotating shaft hole of the bottom shell.

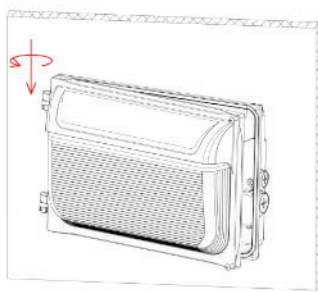

12. Lock the upper cover screws into the bottom shell with a cross screwdriver.

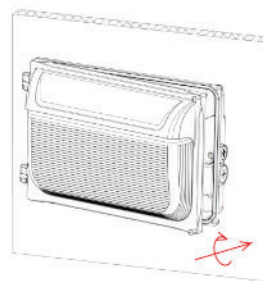

13. Fill the gap between the lamp and the wall with silicone sealant to prevent rainwater from entering the junction box.

