

LED FLOOD LIGHT

INSTRUCTION MANUAL

Please read the user manual carefully and follow it. This will help to prevent damage of the product, prolong its lifespan; And it will be helpful for your normal use and maintenance, to ensure that your life safety. Please keep the manual properly.

Safety Instruction

- Read instructions carefully before attempting to install fixture. Retain instruction for future reference.
- Disconnect power before installing or servicing. This fixture must be wired in accordance with the National Electrical Code and applicable local codes and ordinances.
- All wiring should be performed by a qualified electrician. This fixture is for outdoor use and should not be used in areas with limited ventilation or high ambient temperatures.

INSTALLATION-Surface Mounting

1. Do not remove any part of the fixture.
2. Specification please see the label on fixture.
3. Keep enough length wires to ensure adjusting angle unhindered.
4. Terminal block to be used shall conform to UL standard; and shall be specified as following:
 - the type of terminal: screw/screwless;
 - number of terminals: 3 poles;
 - rated voltage: Min. 277V;
 - any fixing method: fixed inside the connecting box.
5. LED Flood Light must be operated with in an ambient temperature range of -40°C (-40°F) and 45°C (113°F).

Warning

1. Before starting use of the light, please check if the light was damaged during transportation. If any damage shown, please DO NOT install or use it.
2. The products itself and all its components should not be mechanically stressed.
3. Installation must not damage or destroy conducting paths or other parts of the product.
4. Installation of LED product (with power supplies) needs to be made with regard to all applicable electrical and safety standards. Only qualified personnel should be allowed to perform installations.
5. Correct electrical polarity needs to be observed. Wrong polarity may damage or destroy the LED products.
6. All LEDs are static sensitive. Precautions should be taken to ensure that LEDs are well protected from ESD during handing, even though the chips are safe in low static-electric discharge events.
7. DO NOT operate LEDs in reverse bias.
8. Damaged by corrosion will not be honored as a materials defect claim. It is the user's responsibility to provide suitable protection against corrosive agents such as moisture and condensation and other harmful elements.
9. Electrical connection should be in a dry area unless adequately sealed.
10. This product series emits high light output. DO NOT look directly into the light emitting area. Direct exposure to the light over an extended time period may harm eyes.
11. If the external flexible cable or cord of this luminaire is damaged, it shall be exclusively replaced by the manufacturer or his service agent or a similar qualified person in order to avoid a hazard.

Installation Instruction (Slip-fitter)

1. Loosen the screw used to fix the upper and the lower mount in rotating shaft by Hexagon wrench.

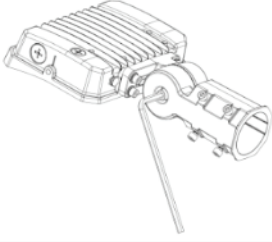

2. Rotate the bracket to proper Angle.

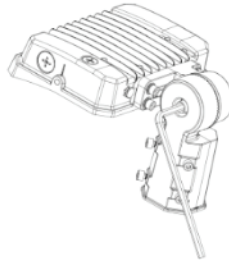

3. Lock the upper and lower brackets by Hexagon wrench.

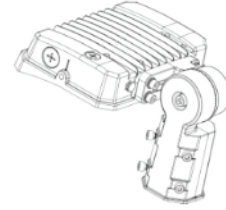

4. Connect wires.

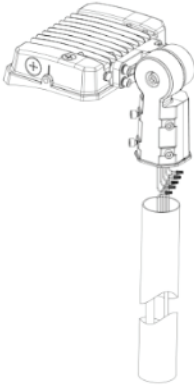

5. Fix the bracket to lamp pole by hexagonal wrench.

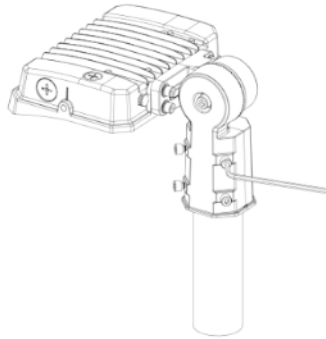

Notice: The maximum diameter of lamp pole is $\varnothing 60$, lamp adjustable angle is 0-90°.

Installation Instruction (Kunckle)

1. Use screw key to open the junction-box.

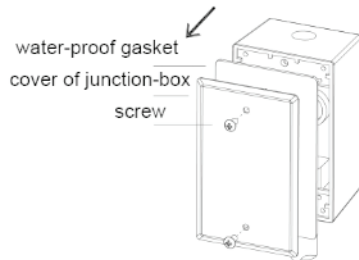

2. Put the wires of lamp into the junction-box.

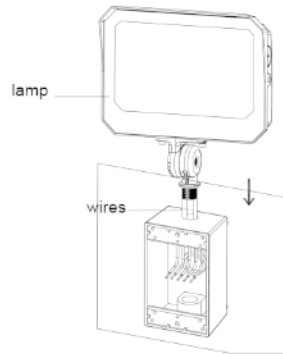

3. Screw up the knuckle mount into junction-box.

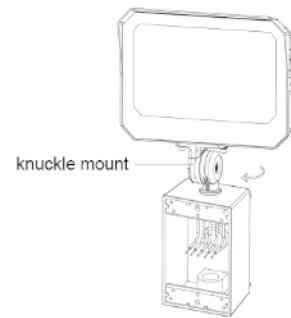

4. Use wire-nuts to connect the wires of lamp and junction-box.

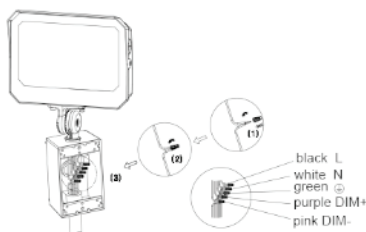

5. lock the junction-box with screw key.

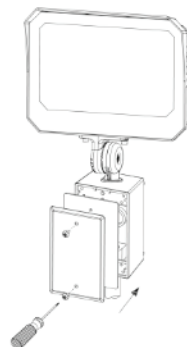

6. Use hex-key to screw off the hex-screw in knuckle mount.

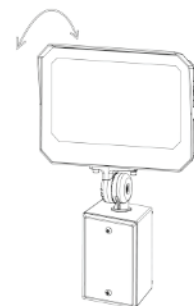

7. Adjust the lamp into suitable angle.

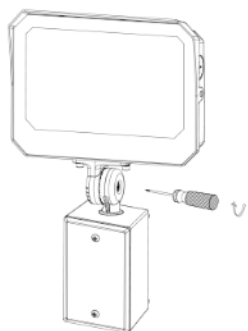

Installation Instruction (Yoke)

1. Mark the position of the fixing holes with fold light bracket, then drill the fixing holes

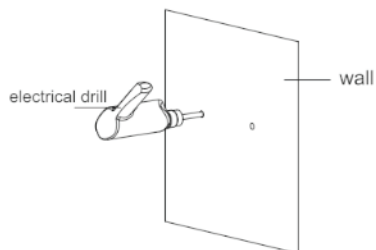

2. Drive in the bolts to the pre-drilled holes with thread outside, as the below pic indicate.

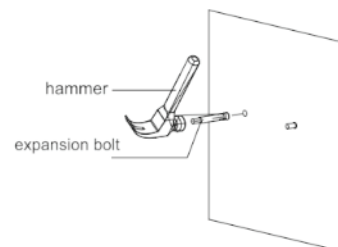

3. Make the bracket face tightly to the wall through the thread.

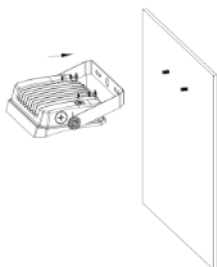

4. Fasten the screw nut clockwise with provided hardware by wrench.

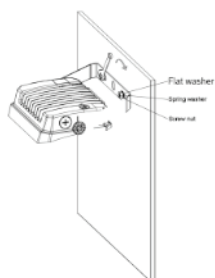

5. Rotate the light to the proper angle and fasten the screws.

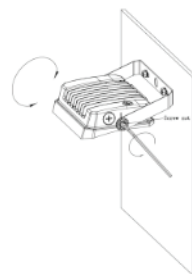

6. Fasten the screw both sides with allen driver.

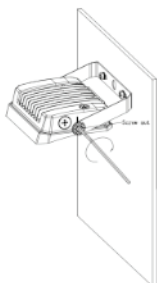

7. Connect wires.

