

Product Description

This luminaire is designed to replace HID lighting systems up to 175w HID. This vapor resistant fixture can withstand extreme physical and environmental abuse and is ideal for retail centers, industrial parks, schools and universities, public transit and airports, office buildings and medical facilities. Designed for architectural wall mounting up to heights of 20 feet based on light level and uniformity requirements.

> Quick Ship - In Stock, Ready to Ship

Project:		Type:
Location:		
Prepared By:		Date:
Comments:		

Performance Summary

- Samsung LH351Z LEDs with high efficacy >115 Lm/W
- USA assembled product with quick warranty support
- Patented heat dissipation design for optimum efficiency
- Vaporproof that withstands extreme physical and environmental abuse
- National listing lab tested to IES standards with Type V 115 degree optic
- High lumen maintenance exceeds DOE requirements
- Photometric optic built over each LED for enhanced light distribution
- Clear flat glass tempered lens for reduced hot spots
- Solid State with high-shock and vibration resistance
- Aluminum LED boards with copper tracings for best thermal management
- LED array manufactured using a state-of-the-art SMT machine
- A360 extruded ingot die-cast housing with integral heat sink
- DuPont architectural powdercoat finish with many RAL options
- Chromate conversion coating for long lasting appearance
- Heavy gauge spun aluminum shade resistant to corrosion and abrasion
- 3/4" fixed NPS threads on mounting plate, arms and fixture
- Fixture includes 72" of power wire to feed through arm and wall box
- Rust resistant stainless steel hardware with durable nickel-plating
- High CRI - RA>80 enhances original colors
- Integrated 1-10V dimmable driver with surge protection 120-277 VAC
- Single fuse or double fuse protection available
- Fast turn on with no warm up or cold start issues
- Contains no mercury, lead, infrared or UV radiation and cool to the touch
- Operating temperature: -40 to 50 degrees celsius
- Samsung TZ chip platform with completed 6,000 hour LM-80 test
- 187,000 hour LED life @ L70 tested at 25 degrees celsius
- Certifications: CE, RoHS, CSA - IP66 sealed LED compartment
- 10 year limited warranty

COMMERCE GOOSENECK AS

Vaporproof with Angled Shade and Multiple Mounting Options

LED Dimmable Luminaire

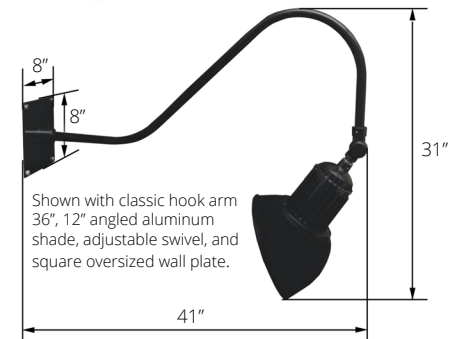

12" Diameter Shade

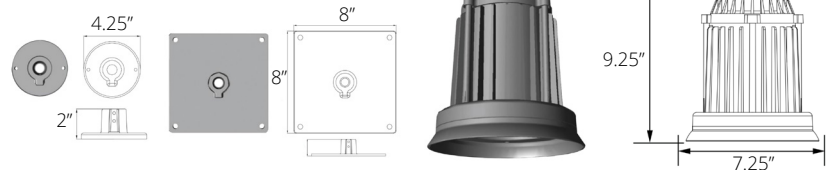

Models:

- WDV53QA: 23W - 2741 Lm - B:1, U:3, G:2

Ordering Information:				Part Number:		
*Adder Applies		**Adder Applies. Extended Lead Time Applies.		Ordering Example: WDV53QA-5-SSC-BK-RM-1336-30A		
Family	CCT	Optic	Housing Finish	Mount to Wall	Mount to Fixture	Shade
WDV53QA	40 - 4000K 50 - 5000K	SSC - Type V 115 Degree Clear Flat Glass Lens	PT - Platinum RAL9006 BK - Black RAL9011** RD - Red RAL3020** WT - White RAL9016** CS - Custom**	NM - No Mount RM - Round Wall Mount* SM - Square Oversized * Wall Mount (Specify mount color if different from housing finish)	NA - No Arm 1336 - Classic Hook Arm 36** 1330 - Classic Hook Arm 30** 2330 - Straight Arm 30** 2324 - Straight Arm 24** 2318 - Straight Arm 18** 2312 - Straight Arm 12** 3330 - Straight Offset Arm 30** 3324 - Straight Offset Arm 24** 4330 - Straight Rise Arm 30** 5330 - Round Hook Arm 30** 5324 - Round Hook Arm 24** 5318 - Round Hook Arm 18**	NS - No Shade 30A - 12" Angled Aluminum* (Specify shade color if different from housing finish)



Vivid Leds, Inc.
PO BOX 9
Sellersburg, IN 47172
330-809-0431
www.vividleds.us

Dimensions, specifications, and product pictures are subject to change without notice.







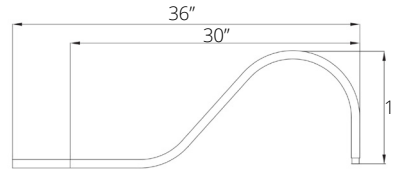

A16

Accessories:

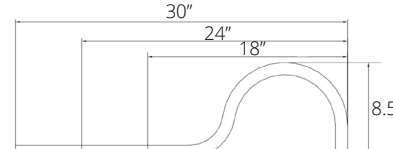
- GNS - Adjustable Swivel

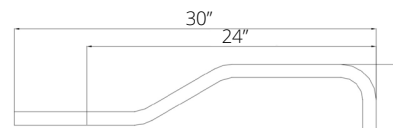
Gooseneck Decorative Arm:

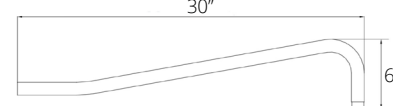
A gooseneck decorative arm provides a classic design appearance for wall mounted adjustable luminaires. The series offers 5 different arm designs with two different styled wall plates. All aluminum heavy duty construction is made specifically for durability for retail centers, universities, restaurants, service stations, and facilities needing architectural styled accent lighting. Multiple fixture series are available for integration with the arm designs, and include all required interface hardware.

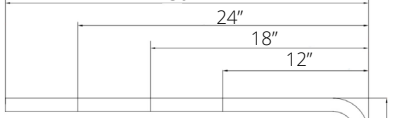
<p>1336 - Classic Hook Arm 36"*</p> <ul style="list-style-type: none"> • Heavy-Duty 3/4" Aluminum Arms with 3/4" NPS Threads on Fixture Mounting End. • Mounts with 3/4" Square or Round Mounting Plates. • Powdercoat Finish Over a Chromate Conversion Coating. Custom Colors Available Upon Request. 		
<p>5330 - Round Hook Arm 30"*</p> <ul style="list-style-type: none"> • Heavy-Duty 3/4" Aluminum Arms with 3/4" NPS Threads on Fixture Mounting End. • Mounts with 3/4" Square or Round Mounting Plates. • Powdercoat Finish Over a Chromate Conversion Coating. Custom Colors Available Upon Request. 		
<p>3330 - Straight Offset Arm 30"*</p> <ul style="list-style-type: none"> • Heavy-Duty 3/4" Aluminum Arms with 3/4" NPS Threads on Fixture Mounting End. • Mounts with 3/4" Square or Round Mounting Plates. • Powdercoat Finish Over a Chromate Conversion Coating. Custom Colors Available Upon Request. 		
<p>4330 - Straight Rise Arm 30"*</p> <ul style="list-style-type: none"> • Heavy-Duty 3/4" Aluminum Arms with 3/4" NPS Threads on Fixture Mounting End. • Mounts with 3/4" Square or Round Mounting Plates. • Powdercoat Finish Over a Chromate Conversion Coating. Custom Colors Available Upon Request. 		
<p>2330 - Straight Arm 30"*</p> <ul style="list-style-type: none"> • Heavy-Duty 3/4" Aluminum Arms with 3/4" NPS Threads on Fixture Mounting End. • Mounts with 3/4" Square or Round Mounting Plates. • Powdercoat Finish Over a Chromate Conversion Coating. Custom Colors Available Upon Request. 		

Photometric Data:

S5C - Type V 115 Degree Clear Flat Glass Lens with Angled Shade

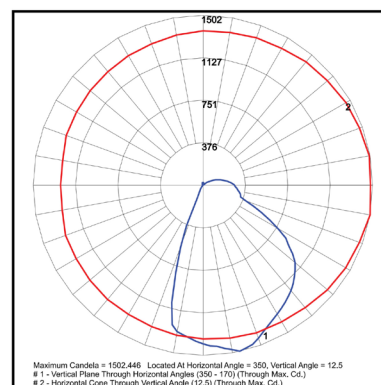

Vivid Leds, Inc.
 PO BOX 9
 Sellersburg, IN 47172
 330-809-0431
 www.vividleds.us

Dimensions, specifications, and product pictures are subject to change without notice.