

## Product Description

The Array AR series is a multi-application luminaire using the latest Philips Lumileds LEDs. From benchmarking a minimum 104 degree F ambient during thermal testing, to custom designed LED arrays for each luminaire individually, to using the best housing materials and coatings, each aspect has been taken into careful consideration to ensure many years of trouble-free service, all at an affordable price.

> Quick Ship - In Stock, Ready to Ship

Project:		Type:
Location:		
Prepared By:		Date:
Comments:		

## Performance Summary

- Philips Lumileds 3030 LEDs with high efficacy >140 Lm/W
- Meets dark sky requirements
- Bronze pole mount accessories available to match the luminaire
- Low profile, 3G vibration rated compact design minimizes wind loads
- Patented heat dissipation design for optimum efficiency
- National listing lab tested to IES standards in Type III, IV, and V distributions
- High lumen maintenance exceeds DOE requirements
- Photometric optic built over each LED for enhanced light distribution
- Solid State with high-shock and vibration resistance
- Rugged one-piece A360 die-cast housing with integral heat sink
- Housing is completely sealed against moisture and environmental contaminants
- Aluminum LED boards with copper tracings for best thermal management
- LED array manufactured using a state-of-the-art SMT machine
- Light engine is available in a 5000K (70 CRI) configuration
- Optics are precisely designed to shape the distribution, maximizing efficiency
- Architectural bronze powdercoat finish
- Chromate conversion coating for long lasting appearance
- Multiple mounting brackets available for many applications
- Rust resistant stainless steel hardware with durable nickel-plating
- Knockouts for optional photocell or occupancy sensor
- 1-10V dimmable driver included with surge protection option
- Fast turn on with no warm up or cold start issues
- Contains no mercury, lead or UV radiation and cool to the touch
- Operating temperature: -40 to 113 degrees F (-40 to 45 degrees C)
- 100,000 hour LED life based on LM-80 results and TM-21 calculation
- Certifications: CE, RoHS, UL, cUL, DLC - IP65 outdoor rated
- 5 year system warranty

## ARRAY AR SERIES

Multiple Applications and Mounting Options  
LED Dimmable Luminaire



## Models:

- VDMAL04040: 40W - 6210 Lm - B:1, U:0, G:1
- VDMAL04070: 70W - 10350 Lm - B:2, U:0, G:2
- VDMAL04100: 100W - 13900 Lm - B:2, U:0, G:2\*\*
- VDMAL04150: 150W - 20800 Lm - B:3, U:0, G:3
- VDMAL04200: 200W - 26000 Lm - B:3, U:0, G:3
- VDMAL04250: 250W - 35250 Lm - B:4, U:0, G:4
- VDMAL04300: 300W - 42000 Lm - B:4, U:0, G:4

Ordering Information:				Part Number:	Ordering Example: VDMAL04040-40-T3-V27-BZ-WM	
Family	CCT	Optic	Voltage	Finish	Mounting	Accessories*
VDMAL04040 VDMAL04070 VDMAL04100 VDMAL04150 VDMAL04200 VDMAL04250 VDMAL04300	50 - 5000K	T3 - Type III T4 - Type IV* T5 - Type V*	V27 - 120-277V V48 - 480V*	BZ - Bronze	WM - Wall Mount Bracket  SQ - Direct Mount Arm for Square or Round Poles  SP - External Mount Slipfitter  YK - Heavy Duty Yoke  TR - Trunnion	SP1 - Surge Protection 120-277V SP2 - Surge Protection 480V PS1 - Twist Lock Photocell Set with Receptacle 120-277V PS2 - Twist Lock Photocell Only 120-277V PS3 - Twist Lock Photocell Set with Receptacle 480V PS4 - Twist Lock Photocell Only 480V PS - Bi-level PIR Sensor 120-277V 4SQ - 4" Square Pole Mount with 2-3/8" O.D. Tenon 5SQ - 5" Square Pole Mount with 2-3/8" O.D. Tenon SPTR - 2-3/8" O.D. Tenon Mount Adapter for Yoke WMSP - Wall Mount Kit with Static Slipfitter SP290 - Horizontal Tenon Adapter, Double 90 Degree SP2180 - Horizontal Tenon Adapter, Double 180 Degree SP490 - Tenon Adapter, Quad 90 Degree Horizontal SQSP - Square Pole Tenon Adapter SP390 - Tenon Adapter, Triple 90 Degree Horizontal SP3120 - Horizontal Tenon Adapter, Triple 120 Degree 4SQR - Tenon Adapter for 4 Inch Round Pole 5SQR - Tenon Adapter for 5 Inch Round Pole



Vivid Leds, Inc.  
PO BOX 9  
Sellersburg, IN 47172  
800-974-3570  
www.vividleds.us

Dimensions, specifications, and product pictures are subject to change without notice.

The product on this page is a manufactured to order, non-stocking item. This product cannot be returned for refund or credit.

A1

Revised 7.26.19

## Photometrics

Type 3 optics produce an asymmetrical pattern that directs the majority of the light forward and equally on both sides of the luminaire. In a back-to-back configuration, it creates a rectangular pattern which can extend pole spacings.

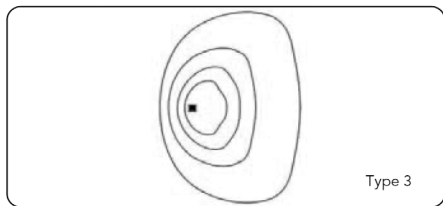



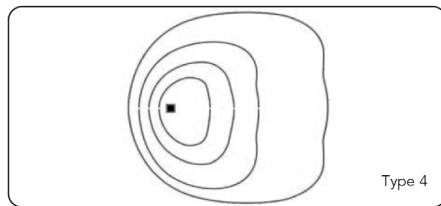

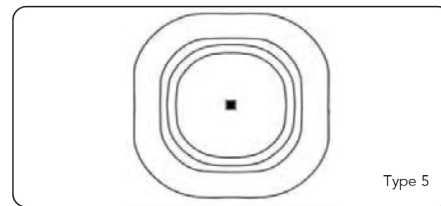

Type 4 is suitable for applications where light is primarily required forward with minimal backlight. Typical installations include perimeter poles.



Type 5 optics produce a symmetrical square distribution pattern that distributes light equally on all sides of the luminaire. Type 5 luminaires is universal for most area lighting applications

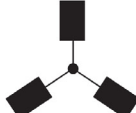

## EPA:

Item							
	1	2 @90°	2 @120°	2@180°	3 @90°	3 @120°	4 @90°
40W/70W/100W	0.3413	0.5929	0.7983	0.6826	1.0239	1.0499	1.0239
150W/200W	0.423	0.735	0.873	0.846	1.158	1.185	1.158
250W/300W	0.4759	0.7889	1.0581	0.9518	1.2648	1.3711	1.2648

## Mounting:

- Standard versatile mounting arm accommodates multiple drilling patterns as well as square and round poles
- Wall Mount available for direct wall mounting and J-box mounting
- Optional for cast aluminum slipfitter mounting adapter



**Arm Mount** (4" and 5" Square and Round poles)  
Standard versatile mounting arm is simple to install and can be used with existing poles for retrofit installations.

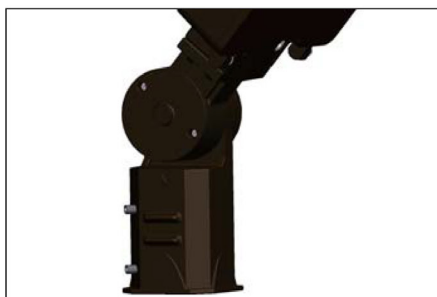

**Slipfitter Mount**  
An optional cast aluminum mast arm adapter secures fixture head to nominal 2"(2-3/8"O.D. pipe size) horizontal steel tenon arm.



**Wall Mount**  
Wall Mount is easy to install for direct wall mounting with 1/2" conduit wiring or standard J-box mounting

## Dimensions:

40W/70W/100W (Slipfitter Mount)

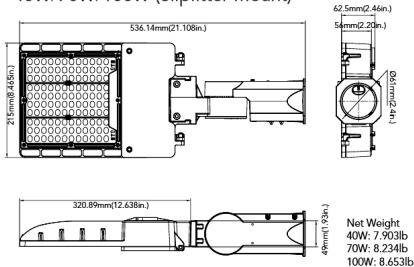

40W/70W/100W (Pole Mount)

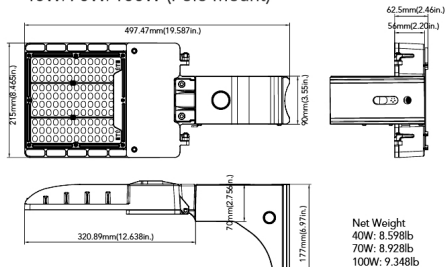

40W/70W/100W (Wall Mount)

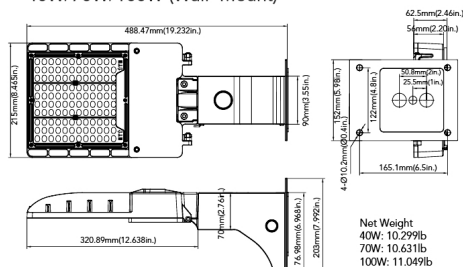

150W/200W (Slipfitter Mount)

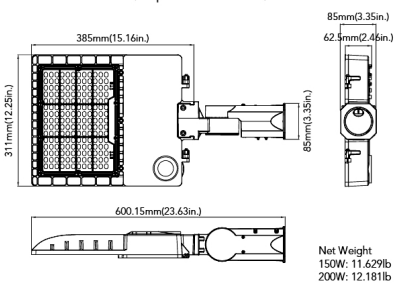

150W/200W (Pole Mount)

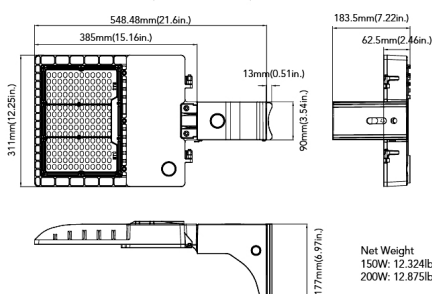

150W/200W (Wall Mount)

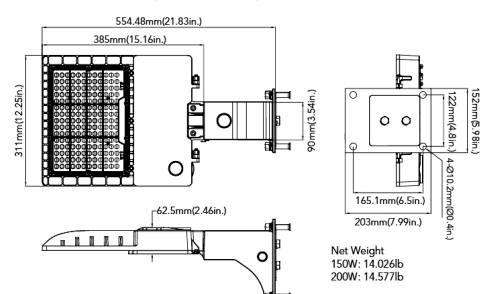

250W/300W (Slipfitter Mount)

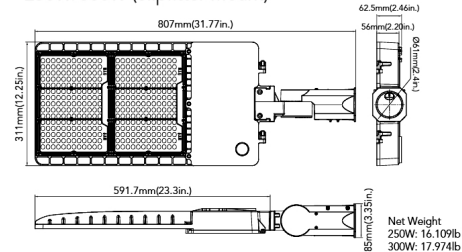

250W/300W (Pole Mount)

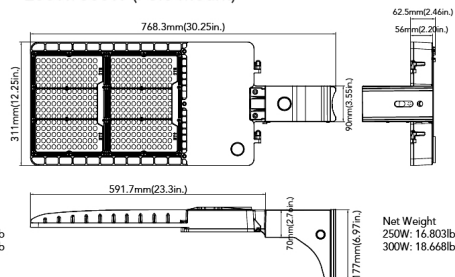

250W/300W (Wall Mount)

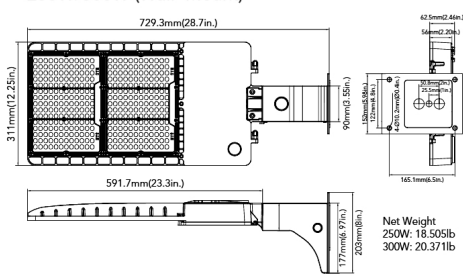

## Arm Mount Detail:

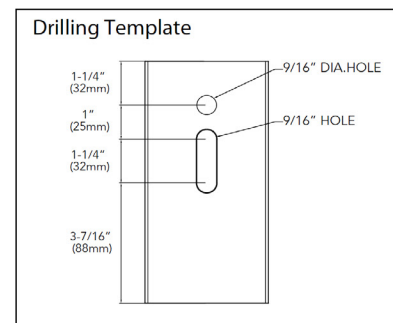
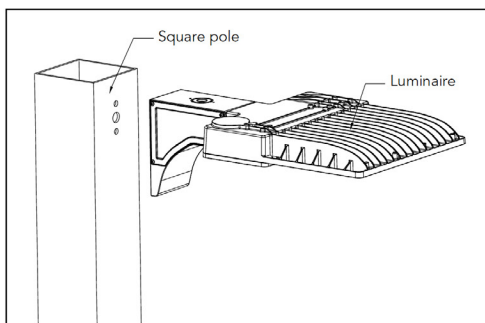
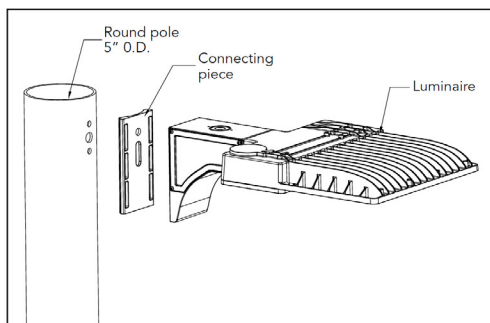

# Pole Accessories:

POLE BRACKET • For mounting one fixture on an existing pole			
	<p><b>4\" Square Pole Mount with 2-3/8\" O.D. Tenon</b></p> <p>Finish: Dark Bronze                      USE: For use with square, non-tapered steel and aluminum poles. Furnished with four 5/16\" hex head stainless-steel bolts. Vertical tenon measures 2-3/8\" O.D., and is made of steel tubing. Fixtures mounted to this bracket can be adjusted both vertically and horizontally.</p>		<p><b>4\" Round Pole Mount with 2-3/8\" O.D. Tenon</b></p> <p>Finish: Dark Bronze                      USE: For use with Round, non-tapered steel and aluminum poles. Furnished with three 3/8\" hex head stainless-steel bolts. Vertical tenon measures 2-3/8\" O.D., and is made of steel tubing. Fixtures mounted to this bracket can be adjusted both vertically and horizontally.</p>
	<p><b>5\" Square Pole Mount with 2-3/8\" O.D. Tenon</b></p> <p>Finish: Dark Bronze                      USE: For use with square, non-tapered steel and aluminum poles. Furnished with four 5/16\" hex head stainless-steel bolts. Vertical tenon measures 2-3/8\" O.D., and is made of steel tubing. Fixtures mounted to this bracket can be adjusted both vertically and horizontally.</p>		<p><b>5\" Round Pole Mount with 2-3/8\" O.D. Tenon</b></p> <p>Finish: Dark Bronze                      USE: For use with Round, non-tapered steel and aluminum poles. Furnished with three 3/8\" hex head stainless-steel bolts. Vertical tenon measures 2-3/8\" O.D., and is made of steel tubing. Fixtures mounted to this bracket can be adjusted both vertically and horizontally.</p>
	<p><b>Pole Bracket accessories-Tenon &amp; Yoke Adaptor</b></p> <p>Finish: Dark Bronze                      USE: The 2-3/8\" OD Tenon Mount Adaptor for Yoke Fixtures is designed to mount light fixtures that are equipped with a yoke mount onto a 2-3/8\" OD tenon. It may be utilized with the Mester Flood Light Series of light fixtures.</p>		
WALL BRACKET • Attaches to any flat surface • Provides wiring access		Mid-Pole tenon Bracket	
	<p><b>90\" Wall Mount Bracket with 2-3/8\" O.D. Tenon</b></p> <p>Finish: Dark Bronze                      USE: The 90\" wall mount bracket with 2-3/8\" tenon attaches an MESTER floodlight to almost any surface: wall, roof, or wood pole. Provides wiring access and a built-in 2-3/8\" O.D. tenon to mount a fixture with our adjustable slipfitter. Suggested 3/8\" diameter bolts for mounting. Mounting holes are spaced 3-1/4\" apart.</p>		<p><b>2-3/8\" OD Horizontal Tenon Mid-Pole Bracket</b></p> <p>Finish: Dark Bronze                      USE: 2-3/8\" OD Horizontal Tenon Mid-Pole Bracket is designed to mount light fixture that is equipped with an adjustable slipfitter onto a 2-3/8\" OD horizontal tenon</p>
Round External Mount Horizontal Tenon • To mount 2/3/4 fixtures on a existing pole			
	<p><b>Double 90\" Horizontal Tenon Adaptor</b></p> <p>Finish: Dark Bronze                      USE: The Bracket is designed to mount over 2-3/8\" (60mm) O.D. vertical tenon. Two fixtures can be mounted to the Round External Mount Horizontal Tenon and adjusted horizontally</p>		<p><b>Triple 120\" Horizontal Tenon Adaptor</b></p> <p>Finish: Dark Bronze                      USE: The Bracket is designed to mount over 2-3/8\" (60mm) O.D. vertical tenon. Three fixtures can be mounted to the Round External Mount Horizontal Tenon and adjusted horizontally</p>
	<p><b>Double 180\" Horizontal Tenon Adaptor</b></p> <p>Finish: Dark Bronze                      USE: The Bracket is designed to mount over 2-3/8\" (60mm) O.D. vertical tenon. Two fixtures can be mounted to the Round External Mount Horizontal Tenon and adjusted horizontally</p>		<p><b>Quad 90\" Horizontal Tenon Adaptor</b></p> <p>Finish: Dark Bronze                      USE: The Bracket is designed to mount over 2-3/8\" (60mm) O.D. vertical tenon. Four fixtures can be mounted to the Round External Mount Horizontal Tenon and adjusted horizontally</p>
	<p><b>Triple 90\" Horizontal Tenon Adaptor</b></p> <p>Finish: Dark Bronze                      USE: The Bracket is designed to mount over 2-3/8\" (60mm) O.D. vertical tenon. Three fixtures can be mounted to the Round External Mount Horizontal Tenon and adjusted horizontally</p>		



Vivid Leds, Inc.  
 PO BOX 9  
 Sellersburg, IN 47172  
 800-974-3570  
 www.vividleds.us

Dimensions, specifications, and product pictures are subject to change without notice.