

MC601V North America Version / Dimming Function

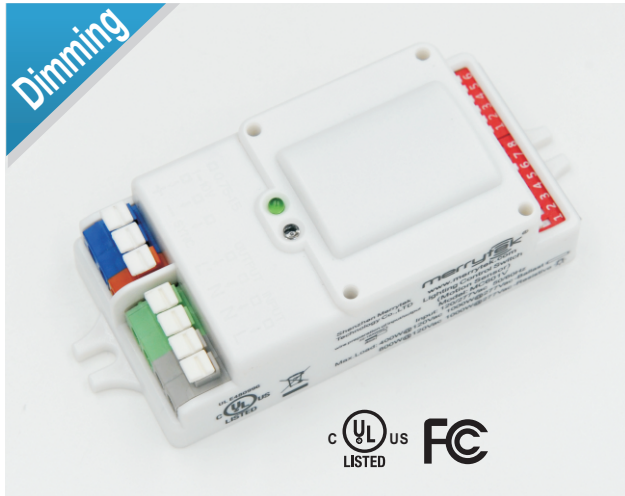

Introduction

- Automatic switching or dimming when used in combination with 1-10V dimmable LED drivers or ballasts.
- Built-in daylight sensor.
- 1-10V interface can match up with Merrytek stand-alone daylight sensor MS01 and achieve daylight harvesting.
- Compact size makes it suitable to fix within most luminaires.
- Detection area, time delay and daylight threshold can be precisely set via DIP switch.
- Wide detection area, range up to 16m in diameter.
- Support higher mounting height 15m Max.
- Optional surface mounting and base mounting

The MC601V innovative and active motion detectors with HF system 5.8GHz. Motion can be detected through plastic, glass and thin non-metal materials.

The sensors allow energy saving without compromising comfort. When used in combination with 1-10V dimmable LED drivers or ballasts, they can achieve 3-step dimming function, which is perfect for use in some areas that requires a light change notice before totally switch off.

Also, the 1-10V interface in the sensors can match up with Merrytek stand-alone daylight sensor MS01, and implement daylight harvesting, means the lighting system has automated controls that either turn off or dim artificial light in response to the available daylight in the space.

As it uses the third generation Merrytek technology, normal 5.8GHz microwave module can easily reach high mounting high up to 15m and long detection area 10m in radius.



Max.8M



Light Sensor



Hold Time
10s~30min



Mounting Height
15 m Max.



Cluster-control
Version



Automatic
Dimming



5 Years
Guarantee

Dimming Function

3-step dimming function

Lamps in corridor are controlled by several sensors. Once any motion is detected by one of sensors, the motion signal will be transmitted to other sensors connected together. Then, all lamps switch on at the same time, instead of switching on the lamps in the area where motion is detected.

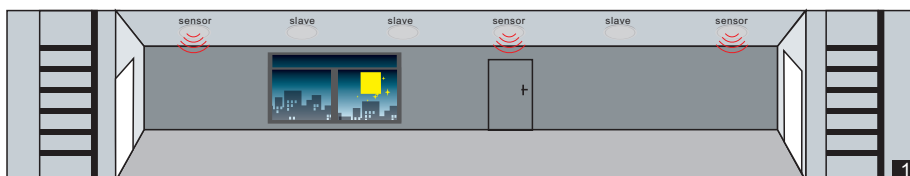

- 1 No motion detected, all lamps switch off.

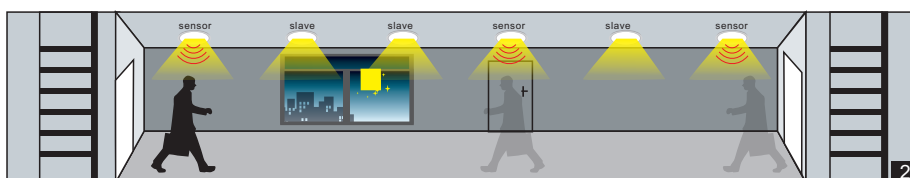

- 2 Any movement is detected from any direction, all lamps synchronously switch on.

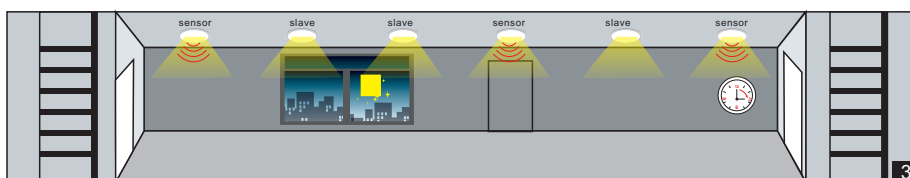

- 3 No motion is detected in detection area, all lamps synchronously dim to a low light level after hold time.

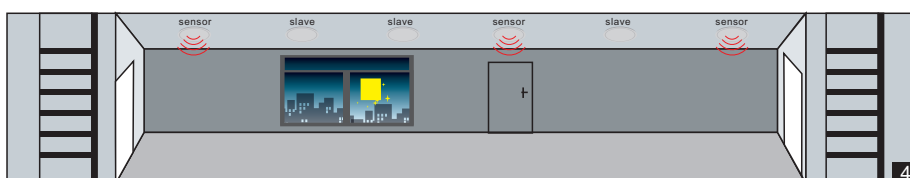

- 4 After stand-by period, the lamps switch off if no movement is detected in the detection zone.

Wiring scheme

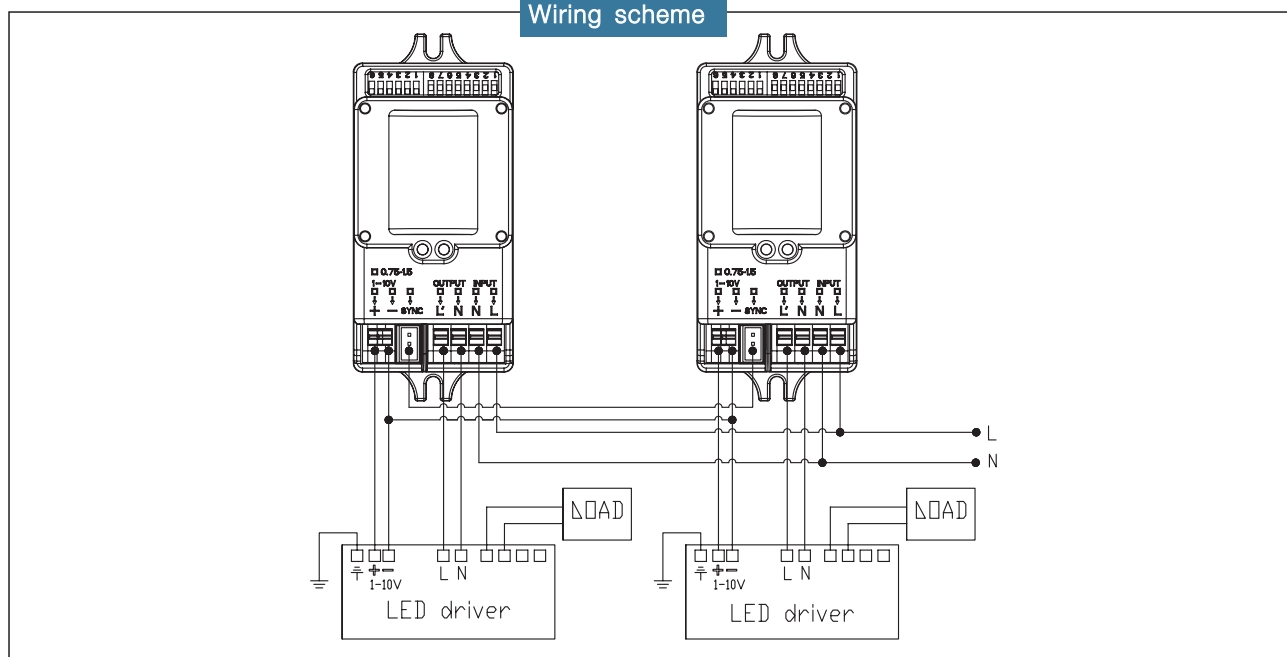

ON -OFF Function

Motion sensor MC601V + LED driver or ballast (Any brand)

MC601V is an innovative motion sensor, switch on the light on detection of movement, and switch off after a hold time when there is no motion detected. As built-in daylight sensor can read brightness value, the sensor does not switch on the light if with sufficient natural light.



With sufficient light, the lamp doesn't switch on.

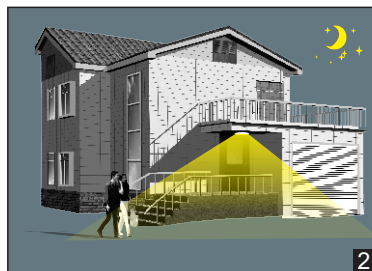

With insufficient ambient light, the sensor switches on the lamp when motion is detected.



After hold time, the sensor switches off the lamp when no motion is detected.

Wiring scheme

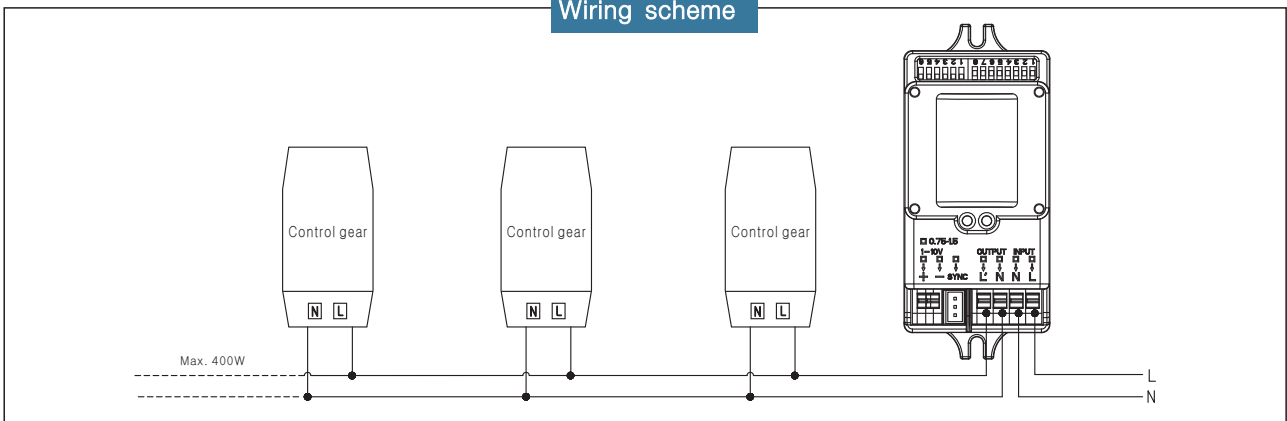

Daylight Harvesting

When used in combination with Merrytek daylight sensor MS01, the system has automated controls that either turn off or dim artificial light in response to the available daylight in the space.



Ambient light larger than preset illumination level (Set by 1-10V daylight sensor), the lamp keeps off.

Ambient light below than preset illumination level, the lamp switches on when motion is detected.

The lamp lights on 100% illumination or dims to maintain the preset illumination level against the level of ambient light.

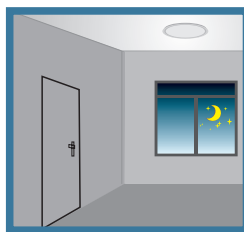
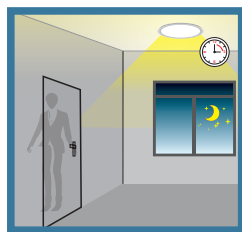
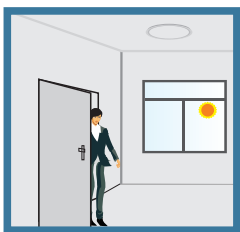

If with sufficient ambient light, the lamp turns off at once, even with motion trigger.

If with insufficient ambient light, the lamp dims to stand-by dimming level (Set in the motion sensor) when no motion detected after hold time, and then switches off after stand-by period.

Wiring scheme

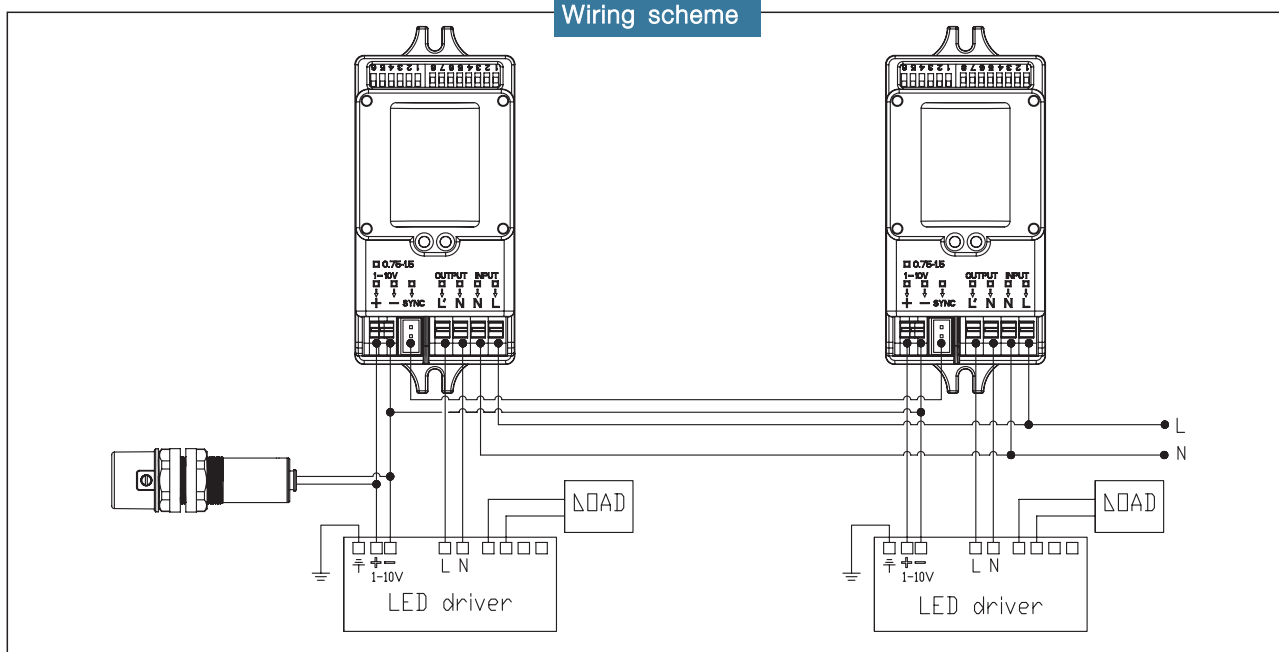

Detection Pattern

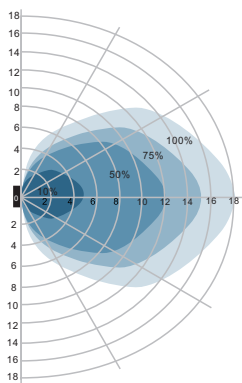

Wall mounting pattern (Unit: m)
Suggested installation height: 1-1.8m

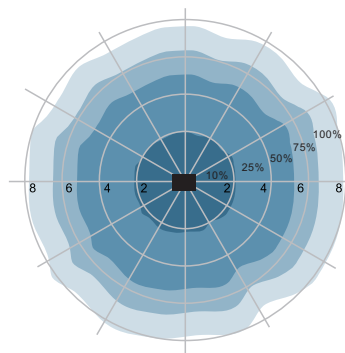

Ceiling mounting pattern (Unit: m)
Suggested installation height: 2.5-10m

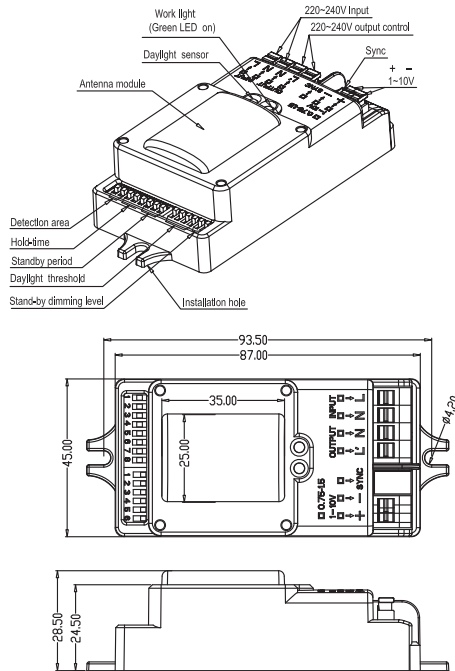

MC601V	
Operating voltage	120~277Vac, 50Hz/60Hz
Rated capacitive load	120V@400W;220-240V@800W;277V@1000W
HF system	5.8GHz±75MHz, ISM wave band
Transmitting power	<0.5mW
Power consumption	≤0.5W(standby), <1W(operation)
Detection zone	Max.(D x H): 16m x 15m
Detection sensitivity	10% / 50% / 75% / 100%
Hold time	5s / 30s / 90s / 3min / 20min / +∞
Daylight sensor	2lux/5lux / 10lux / 25lux/50lux / 100lux / Disable
Stand-by period	0s /5s / 5min / 10min / 30min / 1h / +∞
Stand-by dimming level	10% / 20% / 30% / 50%
Mounting height	15m Max.
Motion detection	0.5~3m/s
Detection angle	150°(wall installation), 360°(ceiling installation)
Operating temperature	-35℃ ~70℃
IP rating	IP20

Setting

By selecting the combination on the DIP switches, sensor data can be precisely set for each specific application.

	1	2	
I	ON	ON	100%
II	ON	-	75%
III	-	ON	50%
IV	-	-	10%

Detection area

Detection area can be reduced by selecting the combination on the DIP switches to fit precisely each application .

	3	4	5	
I	ON	ON	ON	5S
II	-	ON	ON	30S
III	ON	-	ON	90S
IV	-	-	ON	3min
V	ON	ON	-	20min
VI	-	-	-	+∞

Hold time

Refers to the time period the lamp remains at 100% illumination after no motion detected.

	6	7	8	
I	ON	ON	ON	0S
II	-	ON	ON	5S
III	ON	-	ON	5min
IV	-	-	ON	10min
V	ON	ON	-	30min
VI	-	ON	-	1h
VII	-	-	-	+∞

Stand-by period

Refers to the time period the lamp remains at a low light level before it completely switches off in the long absence of people.
When set to "+∞" mode, the low light is maintained until motion is detected.

	1	2	3	4	
I	-	-	ON	ON	2Lux
II	-	-	-	ON	5Lux
III	-	ON	ON	-	10Lux
IV	-	-	ON	-	25Lux
V	-	ON	-	-	50Lux
VI	ON	-	-	-	100Lux
VII	-	-	-	-	Disable

Daylight sensor

The sensor can be set to only allow the lamp to illuminate below a defined ambient brightness threshold.
When set to Disable mode, the daylight sensor will switch on the lamp when motion is detected regardless of ambient light level.
50lux, 30lux: twilight operation, 10lux, 5lux: darkness operation only.
Note that daylight sensor is active only when lamp totally switches off.

	5	6	
I	ON	ON	50%
II	-	ON	30%
III	ON	-	20%
IV	-	-	10%

Stand-by dimming level

The low light level you would like to have after the hold time in the long absence of people.