

LED POOL LIGHT

ITEM NO.:
ITEM NO.: Focus LS

INSTRUCTION OF LED POOL LIGHT

This product is mainly used for swimming pool, underwater fixture. With friendly and convenient operation, it can offer magic effects in water and ground.

A. Specification

A-1. Structure

Materials of Shell: Aluminum alloy/6063
 Rotary angle: 150°
 Input Voltage: 24V DC
 Protecting Rating: IP68
 Operating Temperature: -20°C~40°C



LPL618



LPL636

A-1. Model Configuration Table

Model No.	LED Color	LED Quantity	Power Consumption	Beam Angle	Size	Weight	✓
LPL618	R, G, B	18	23 WATTS	10°/20°/45°	∅ 170xH180mm	2.6kg±5%	
LPL636	R, G, B	36	45 WATTS	10°/20°/45°	∅ 210xH190mm	4.4kg±5%	

B. Working mode

- B-1. DMX512 mode (signal from DMX console)
- B-2. Built-in mode
- B-3. Master/Slave mode Mode(Master=001, Slave≠001)

C. Function & Setup

C-1. DMX Channel instruction-3 Channels available as sheet:

CHANNEL 1		CHANNEL 2		CHANNEL 3	
Data	Function	Data	Function	Data	Function
0~255	Brightness of Red	0~255	Brightness of Green	0~255	Brightness of Blue

***Enter or quit DMX mode automatically once detecting valid signal!!!

C-2. DMX Address Setting

Press the MODE button to the interface as Figure 3, the address(A,B,C,D,E,F) display on the LCD screen are corresponding to the output port on the controller (1 # 2 # 3 # 4 # 5 # 6 #). Press SET button to choose different output port; Press the UP and Down button to the desired address, each port can set as digits less than 512.

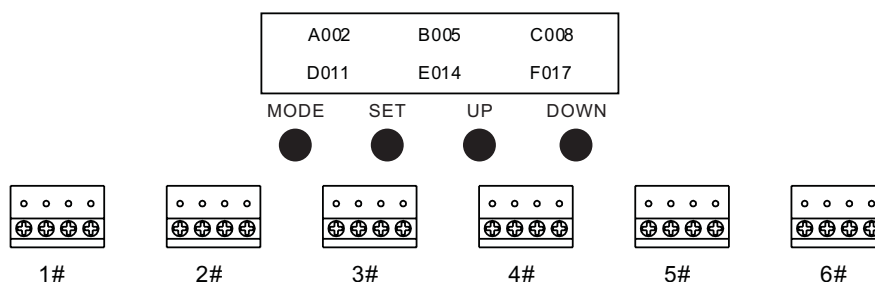

LED POOL LIGHT

C-3 .Program Menu

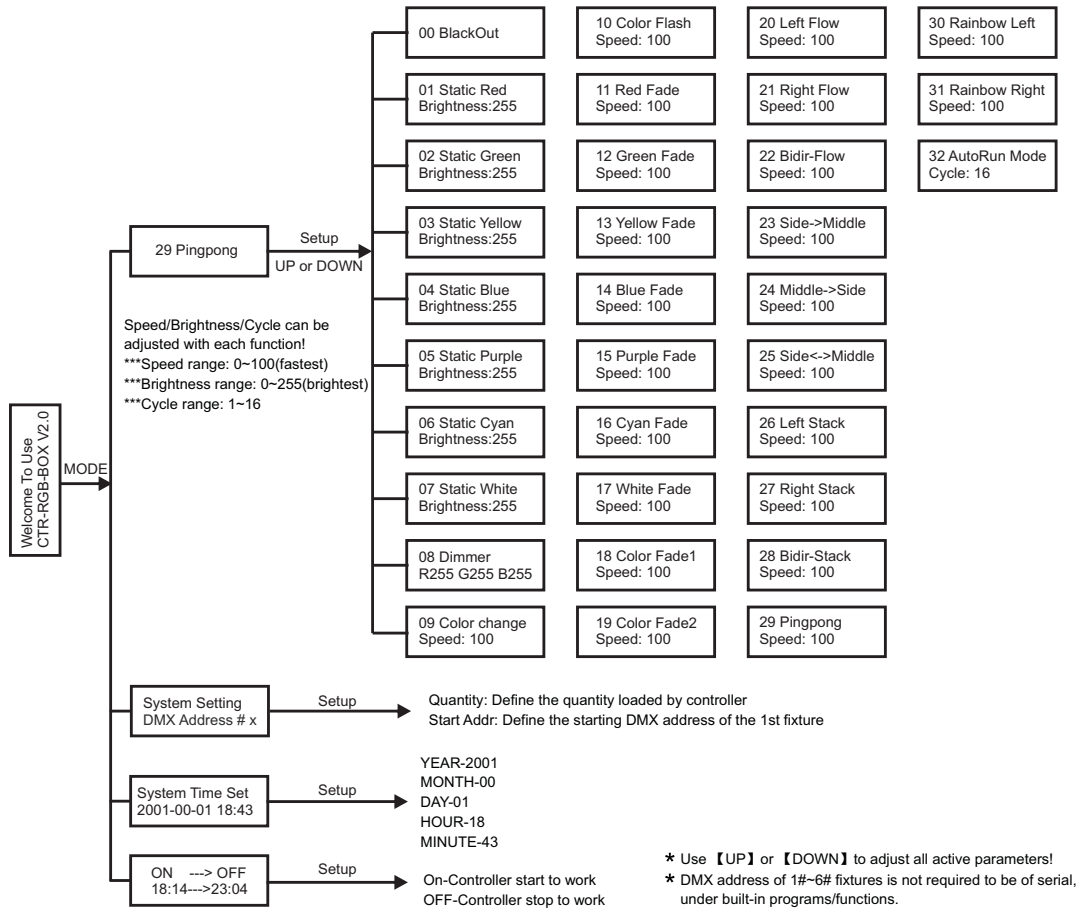

D.Photometrics

D-1. Cadela distribution

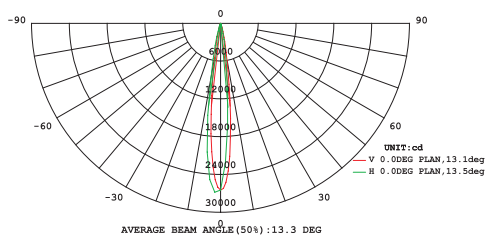

LPL-6-36P-240V-W-15°

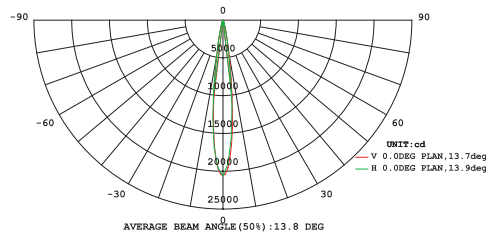

LPL-6-36P-240V-WW-15°

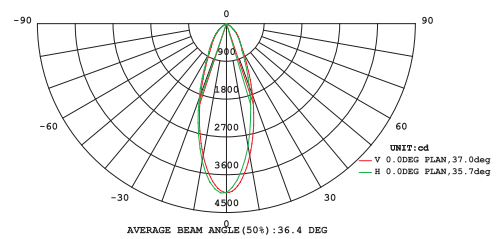

LPL-6-36P-240V-W-45°

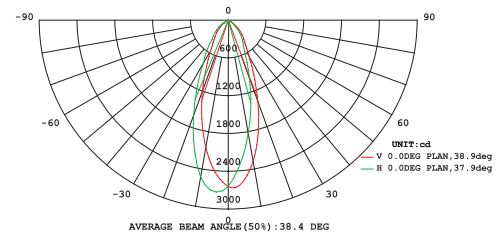

LPL-6-36P-240V-WW-45°

D-2.Illuminance at a distance

LED POOL LIGHT

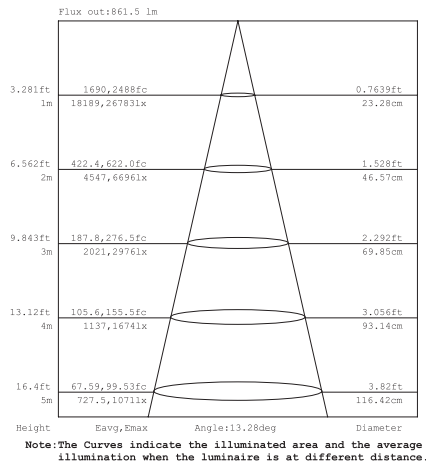

LPL-6-36P-240V-W-15°

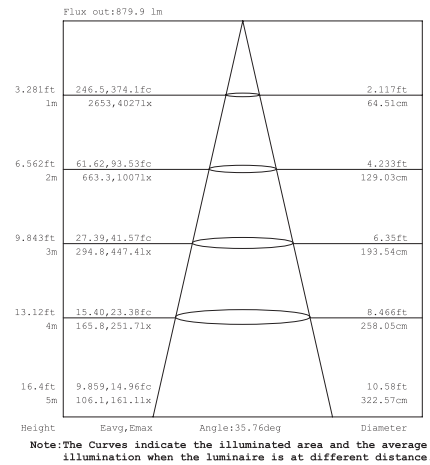

LPL-6-36P-240V-W-45°

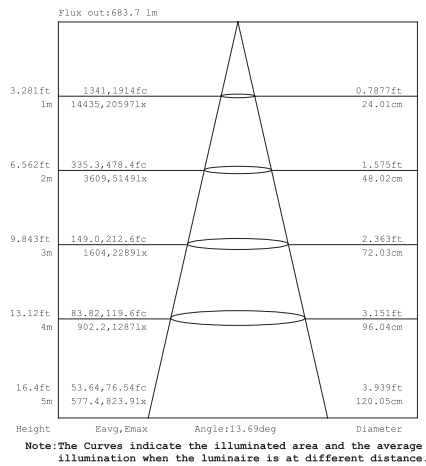

LPL-6-36P-240V-WW-15°

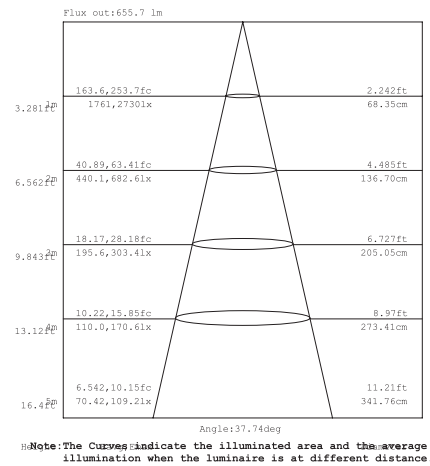

LPL-6-36P-240V-WW-45°

E.Dimension drawing

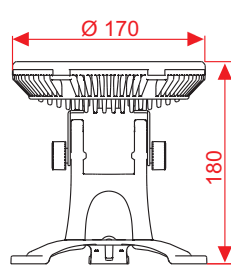

LPL-6-18P

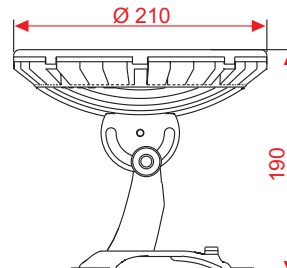

LPL-6-36P

F.Installation

Fix the brackets via M6 tapping screw,mounting size as below:

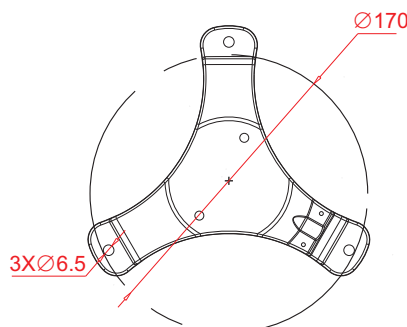

LED POOL LIGHT

G. Connection

Black wire ----- V+

Red wire ----- R

Green wire ----- G

Blue wire ----- B

***Please refer to actual definition of color of cable in different fixtures.

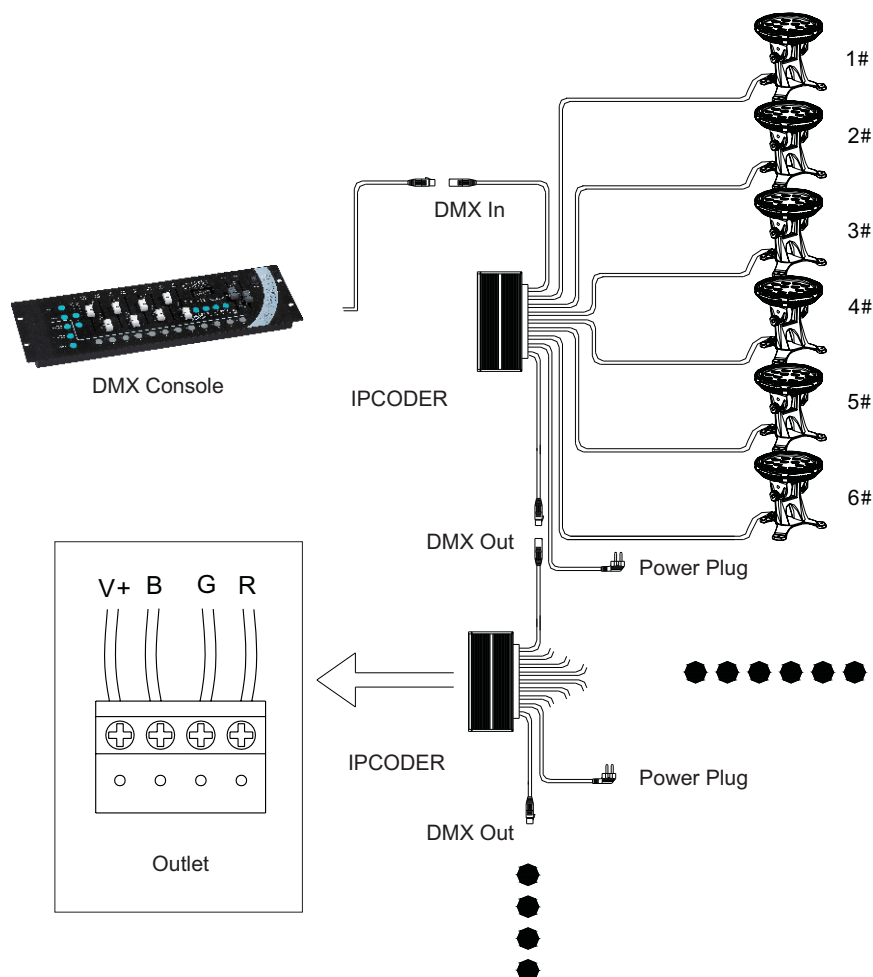

Caution:

1. Do not plug them into power when the product is still in package;
2. Don't use anything to cover the fixture during application;
3. Don't use this product in close environment;
4. If this product appears to be damaged, do not attempt any repair, please contact your dealer.

Warning:

- * Neglect on action of the above treatment will lead to failure of waterproof and proper working of the lights!!
- * Make sure the ground connection well avoid electric shock, due to metal housing.